

Operating Instructions & Parts Manual

Please read and save these instructions. Read carefully before attempting to assemble, install, operate or maintain the product described. Protect yourself and others by observing all safety information. Failure to comply with instructions could result in personal injury and/or property damage! Retain instructions for future reference.

Floating Pond Pump System 1/2, 3/4 & 1 HP 230V Models FPS05021, FPS07021, FPS10021



Floating Pond Pump System 1/2, 3/4 & 1 HP 230V Models FPS05021, FPS07021, FPS10021

Description

This pump system is designed for decorative use and can improve water aeration. Operates in 5 feet of water or deeper. Do not pump water above 120° F. Make your floating fountain system even more dramatic at night by adding NightBright lighting system 023069. See specifications for water displacement and fountain height.

General Safety Information

Carefully read and follow all safety instructions in this manual and on pump. Keep safety labels in good condition. Replace missing or damaged safety labels.

 **This is a SAFETY ALERT SYMBOL.** When you see this symbol on the pump or in the manual, look for one of the following signal words and be alert to the potential for personal injury or property damage.

 **DANGER** Warns of hazards that **WILL** cause serious personal injury, death or major property damage if ignored.

 **WARNING** Warns of hazards that **CAN** cause serious personal injury or death, if ignored.

 **CAUTION** Warns of hazards that **MAY** cause minor personal injury, product or property damage if ignored.

IMPORTANT: Indicates factors concerned with operation, installation, assembly or maintenance which could result in damage to the machine or equipment if ignored.

NOTE: Indicates special instructions which are important but are not related to hazards.

 **WARNING** Read these warnings and instructions carefully. Failure to follow could result in serious bodily injury and/or property damage.

 **WARNING** This unit not tested for use in swimming pool areas.

 Electrical installations shall be in accordance with National Electric Code (NEC) and all applicable

local codes and ordinances. A licensed electrician should perform installation.

WARNING

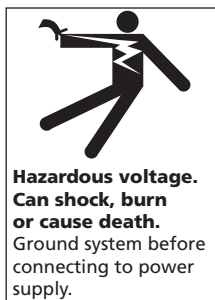



 Be sure system is connected to a circuit equipped with a fuse or circuit breaker of proper size.

 Protect the power cable from coming in contact with sharp objects, oil, grease, hot

surfaces or chemicals. **DO NOT** kink the power cable. If damaged replace immediately.

 Install all electrical equipment in protected area to prevent mechanical damage which could produce serious electrical shock and/or equipment failure.

 **NEVER** leave the control box, fused disconnect switch, or covers open (either partially or completely) when not being worked on by a competent electrician or repairman.

 Always disconnect power source before performing any work on or near the motor or its connected load. If the power disconnect point is out-of-sight, lock it in the open position and/or tag it to prevent unexpected application of power. Failure to do so could result in fatal electrical shock or bodily injury.



DANGER

DO NOT use this system to pump flammable liquids such as gasoline, fuel oil, kerosene, etc. Failure to follow the above warning

Specifications

230V, 1/2, 3/4 or 1 HP

Requires 5' or greater water depth

100' power cord

Water Lily attachment nozzle displaces:

1/2 HP 4,900 GPH at 15 Ft.
3/4 HP 5,825 GPH at 22 Ft.
1 HP 6,150 GPH at 24 Ft.

Sky Canon attachment nozzle displaces:

1/2 HP 3,300 GPH at 15 Ft.
3/4 HP 4,100 GPH at 35 Ft.
1 HP 4,200 GPH at 41 Ft.

Water Trumpet attachment nozzle displaces:

1/2 HP 2,700 GPH at 13 Ft.
3/4 HP 3,400 GPH at 20 Ft.
1 HP 3,600 GPH at 22 Ft.

could result in property damage and/or personal injury.

Unpacking

Unpack and inspect system for damage. Verify you have received the following components:

1. Instructions
2. Warranty
3. Pump/float unit.
 - a. Float with nozzle (Water Lily 2C) attached by 4 screws.
 - b. Screen attached to float by 2 hex bolts with lock washers and 2 eyebolts with hex nuts 180° apart.
 - c. 100ft cord secured to bottom cap with strain relief.
4. Control center.
 - a. Pump timer
 - b. Light timer
 - c. 4 mounting brackets with bolt kit
5. Shrink tube splice kit
6. 2 additional nozzles
 - a. Sky Cannon (Fig 2)
 - b. Water Trumpet (Fig 3)

Floating Pond Pump System

INSTALLATION INSTRUCTIONS Fountain Installation

1. Required Tools and Supplies:
 - a. 3/8" or larger nylon rope to anchor/moor fountain unit
 - b. Stakes or weights to anchor/moor unit
 - d. Flat screwdriver
 - e. 5/16" Nut driver
 - f. Crimping tool (for cable splicing only)
 - g. Torch or heat gun for shrink tube splice kit(for cable splicing only)
 - h. Multimeter to check voltage, current and insulation resistance to ground
 - i. Post(s) to mount control center
 - j. Bolts to attach control center to post(s)
2. Prepare unit for installation in pond
 - a. The unit ships with the Water Lilly nozzle installed. Refer to Figures 1, 2 and 3 for spray pattern appearance. To change to one of

the other 2 nozzles, remove the 4 screws with a 5/16" nut driver or flat screwdriver and replace with desired nozzle. Nozzles are marked "This side up". Make sure o-ring is seated in groove before installing nozzle. Tighten screws until seated, approximately 10 to 12 in-lbs.

- b. If installing the optional "Night Bright" lighting system, follow instructions included with light system for proper installation.
- c. Determine length and proper size of cable per Wire Size Table 1. Splice additional cable up to 250 feet total cable length using included heat shrink splice kit. **DO NOT EXCEED** maximum cable length or use smaller cable than specified as system damage may occur.

1. Only install this system in ponds where no swimming, wading, boating or fishing is allowed while system is operating. Disconnect power to pump before fishing or entering the water.
2. Post appropriate warning signs per local and state codes.
3. Install fountain in pond. (See Fig 4 for typical installation).
 - a. Prior to installation, measure water depth. All fountains require 5 ft minimum water depth for proper operation.
 - b. Position anchor weights or mooring stakes 180° apart and equidistant from desired fountain location. Attach nylon anchor/mooring ropes to weights or stakes then attach to 2 eyebolts located at top of fountain screen. Make sure to leave only enough slack in rope to accommodate anticipated water level fluctuations.



! DANGER

Never enter the water either wading, swimming or in a boat with the pump power on, as this may result in severe electrical shock.

Wiring Sizes

Table 1

Wire size for Service Entrance to Fountain control center with 100 ft of 14 AWG pump cable from control center to fountain

Fountain HP Rating	Starting Current Amps	Length of wire from service entrance to control center								
		100	150	200	250	300	350	400	450	500
1/2	32.2	14	14	14	14	14	12	12	12	10
3/4	40.7	14	14	14	12	12	10	10	10	10
1	48.7	14	14	12	10	10	10	8	8	8

Wire size for Service Entrance to Fountain control center with 250 ft of 14 AWG pump cable from control center to fountain

Fountain HP Rating	Starting Current Amps	Length of wire from service entrance to control center								
		100	150	200	250	300	350	400	450	500
1/2	32.2	14	14	12	10	10	10	8	8	8
3/4	40.7	10	8	8	6	6	4	4	4	2
1	48.7	10	8	8	6	6	4	4	4	2

Note: 250 ft maximum cable length from control center to fountain pump motor for proper GFI operation. Wire from service entrance(main fuse/circuit box) to control center must be sized to provide starting current amps at control center. Call customer service help line at 1-800-742-5044 for other wire combinations.

1/2, 3/4 & 1 HP Models

- c. Place power cord so that it rests on bottom of pond away from sharp rocks or vegetation so it can be easily removed without being damaged or becoming entangled. Leave enough slack to accommodate anticipated water level fluctuations.

NOTE: It is suggested that the underwater power cables be installed in conduit from the panel to 4 -5 ft into the water to prevent possible cable damage.

- 4. Before connecting the unit to the control center, check to insure there is no leakage to ground. This can be done by using an ohm meter and setting the scale to its highest setting (i.e. Rx100K). Connect one ohmmeter lead to the unit power cord ground and to one of the power conductors. It should read infinite or at least 2 mega ohms. Repeat with the other conductor. If reading is below 2 mega ohms on either conductor contact Customer Service Help Line at 1-800-742-5044.



! DANGER

"NO SWIMMING" AND OR WARNING SIGNS SHOULD BE POSTED PER STATE AND LOCAL CODES.

! CAUTION

Water leaving nozzle is at high velocity and can cause bodily injury if contact is made.



! DANGER

Always use caution when operating electrical controls in damp areas. If possible, avoid all contact with electrical equipment during thunderstorms or extreme damp conditions.

System Control Center installation and electrical connection

- 1. All work must be done in compliance with local and national electrical codes by licensed, qualified electrician. Refer to Fig. 6 in these

instructions or on inside of panel door for proper wiring.

- 2. Control Center mounting location. (See fig. 4 for typical installation)
 - a. Mount control center a minimum of 3 feet above ground and a minimum of 3 feet above the high water level in a flood zone.
 - b. Mount control center a minimum of 5 feet horizontally from shoreline during maximum flood condition. (Control center must not be accessible from water)
 - c. Always keep control center door closed, bolted and locked when not servicing.
- 3. Have a licensed, qualified electrician make final connections of fountain and optional lights to system control center.
- 4. Have a licensed, qualified electrician install disconnecting means in compliance with local and national electrical codes.
- 5. Have a licensed, qualified electrician make connection to power source.
- 6. Apply power to unit and set timers as described in the Setting Timers section.
- 7. Test the ground fault interrupter for proper operation by depressing the "test" button. (See Fig. 6) The fountain should shut off. Press the "reset" button to restart the system. If pressing the "test" button does not stop the unit, immediately shut off power to unit and contact Customer Service Help Line at 1-800-742-5044.



! WARNING

FAILURE TO CONNECT THIS UNIT TO A PROPERLY GROUNDED POWER SUPPLY MAY RESULT IN SEVERE ELECTRICAL SHOCK.

Setting timers

NOTE: Set the pump timer for all installations. Set the light timer when installing the optional NightBright lighting system.

IMPORTANT: Rotate the dial in clockwise direction only! Rotating dial counter clockwise will damage the timer!

- 1. Set the on-off time zones.
 - a) The timer consists of 96 setting pins. Each represents 15 minutes in a 24 hour day revolution. Fold the pins inward during the time of day/ night the pump and/or lights are desired to run.
- *Do not attempt to fold in the 8 closest pins to the "present time". This can damage the switch. Proceed with these pins by turning the inner dial clockwise until they are 4 pin locations away from the "present time". Once cleared of this location, fold inward the desired pins.
 - b) Rotate the dial clockwise to verify operation of the trippers.
 - c) The timer may be overridden by repositioning the manual switch in the bottom right hand corner of the timer. In the ON position the output power will be continuous regardless of the timer pin settings. In the OFF position the output power will be cut off regardless of the timer pin settings. The output power will be turned on and off at the set points when in the AUTO position.

- 2. Setting the clock. (24 hr clock)

- a) Turn the dial clockwise until the arrowhead is aligned with the Present Time.
- b) The timers include built in battery backup for maintaining time during power outages.

Floating Pond Pump System

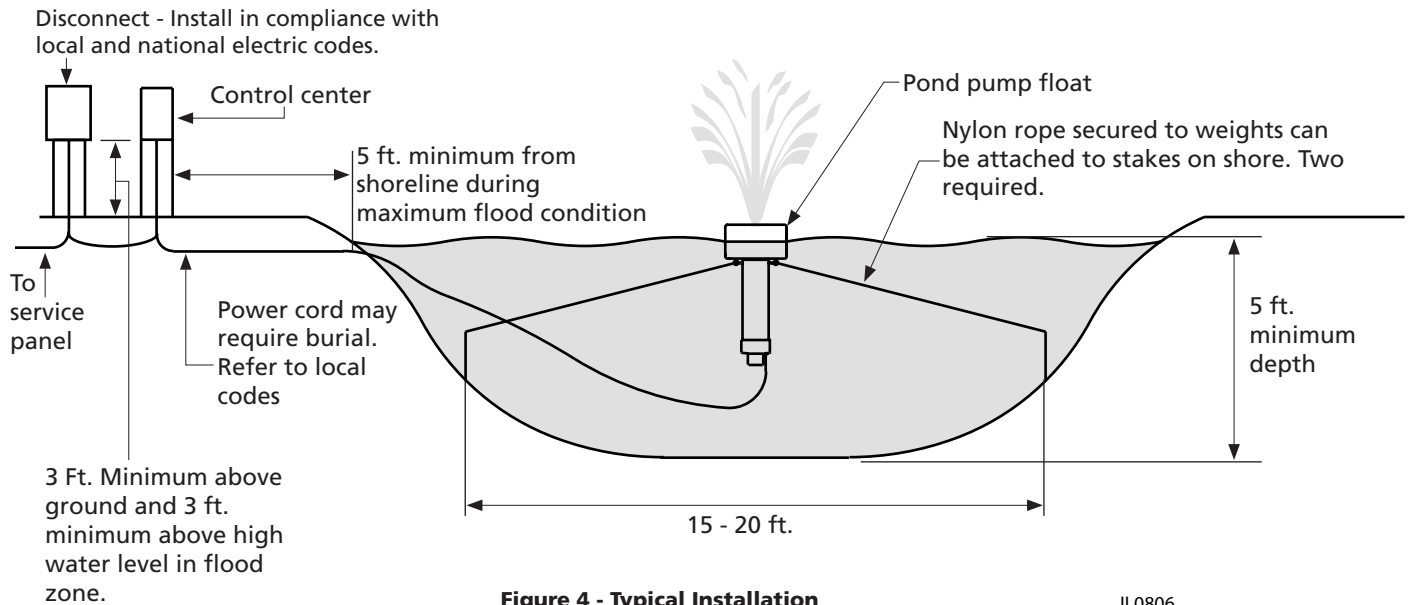

Figure 4 - Typical Installation

IL0806

NOZZLE PATTERNS

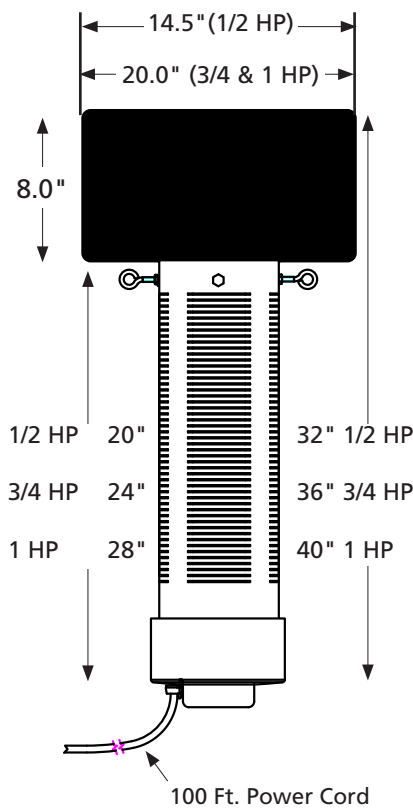

Figure 5 - Dimensions



Figure 1 - Water Lily: (Factory Installed) An eye-catching combination spray. Item #2C

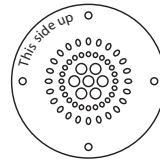

Figure 3 - Water Trumpet: A symmetrical inverted bell shape. Item #2A

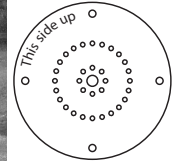
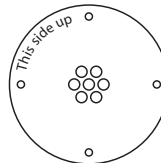

Figure 2 - Sky Cannon: A dramatic single plume of water. Item #2B



1/2, 3/4 & 1 HP Models

INSTALLATION CHECK LIST

- Read installation instructions and warnings.
- Post appropriate warning signs.
- Install desired spray nozzle.
- Install and anchor unit in pond.
- Connect control center to properly grounded supply.
- Check insulation resistance to ground.
- Power up unit.
- Test operation of GFI by pressing the "Test" Button. (See Fig 6).
- Set Timer.
- File instructions for future reference.



⚠ WARNING

DO NOT handle pump with wet hands or when standing in water as fatal electrical shock could occur. Disconnect main power supply before handling system for any reason.

MAINTENANCE

1. Test the GFI monthly by depressing the test button.
2. The screen and nozzle should be cleaned as required to maintain proper water flow.
3. At least once a year, thoroughly inspect the fountain, underwater cable and anchor/mooring lines for physical damage. Replace any damaged components.

WINTER STORAGE

1. Remove fountain from pond.
2. Check for damage.
3. Clean unit prior to storage.
4. In freezing climates, store in heated space to prevent damage to water lubricated motor.

⚠ CAUTION

The pump motor is water lubricated and is factory filled with an antifreeze solution. During operation the antifreeze may exchange, thru the filtered check valve, with the pond water. In climates where freezing may occur, the unit must be stored in a heated storage space to prevent damage to the motor.

Troubleshooting Chart

Symptom	Possible Cause(s)	Corrective Action
Unit won't run	<ol style="list-style-type: none"> 1. Circuit breaker tripped 2. Low Voltage 3. GFI Tripped 4. Excessive Cable Length 5. Timer/clock not set 	<ol style="list-style-type: none"> 1. Reset circuit breaker. 2. Verify voltage. 3. Reset GFI. 4. Verify acceptable maximum cable length. 5. Set clock to local time and timers for desired cycle. See Section on Setting Timers.
No or low spray	Blocked screen or nozzle, missing or damaged o-ring, or incorrectly installed nozzle	Disconnect power. Clean screen and/or nozzle. Check that o-ring is undamaged and seated in groove. Check that nozzle is installed properly (nozzles are marked "This side up"). Check depth of pond. If less than 5 feet deep, move to deeper section. Restart unit.
GFI Trips	<ol style="list-style-type: none"> 1. Electrical storm can trip GFI 2. Short in system 3. Defective power cable 	<ol style="list-style-type: none"> 1. Reset GFI. 2. Disconnect power and check cord for damage. If cord is damaged contact customer service help line at 1-800-742-5044. 3. Disconnect power and check cord for damage. If cord is damaged contact customer service help line at 1-800-742-5044.
Unit spins	Anchor rope(s) loose	Check anchor rope(s) and re-attach if necessary.

Floating Pond Pump System



⚠ DANGER *Never enter the water either wading, swimming or in a boat with the pump power on, as this may result in severe electrical shock.*

⚠ WARNING *This product contains chemicals known to the State of California to cause cancer and birth defects or other reproductive harm.*

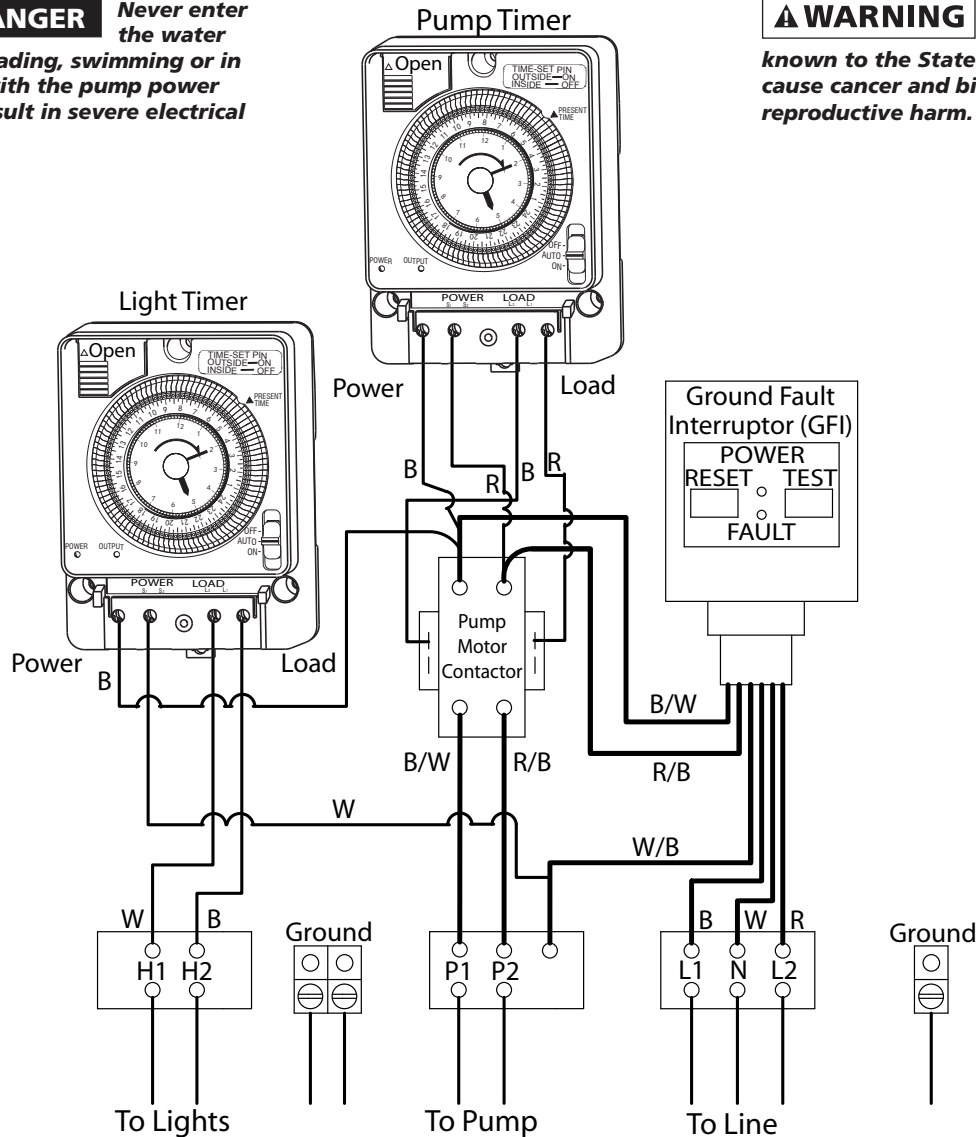

IL0809

⚠ WARNING

Hazardous voltage. Can shock, burn or cause death. Ground system before connecting to power supply.

⚠ *Electrical installations shall be in accordance with National Electric Code (NEC) and all applicable local codes and ordinances. A licensed electrician should perform installation.*

⚠ *Be sure system is connected to a circuit equipped with a fuse or circuit breaker of proper size.*

⚠ *NEVER leave the control box, fused disconnect switch, or covers open (either partially or completely) when not being worked on by a competent electrician or repairman.*

⚠ *Always disconnect power source before performing any work on or near the motor or its connected load. If the power disconnect point is out-of-sight, lock it in the open position and/or tag it to prevent unexpected application of power. Failure to do so could result in fatal electrical shock or bodily injury.*

Figure 6 - Control Center Schematic

Ref No.	Description	Part No.			Qty
		1/2 HP	3/4 HP	1 HP	
*	Screw - #10 x 3/4 Slotted Hex Head or Pan Head Sheet Metal Screw (18-8 Stainless Steel)	*	*	*	6
2A	Nozzle - Water Trumpet	021617	021617	021617	1
2B	Nozzle - Sky Cannon	021618	021618	021618	1
2C	Nozzle - Water Lily	021619	021619	021619	1
3	O-Ring - AS568A - 041 (3" ID x 3/18" OD)	021622	021622	021622	1
4	Bolt - SS 1/4-20 x 3/4	*	*	*	4
5	Lockwasher SS - 1/4"	*	*	*	6
6	Mounting Flange	021707	021707	021707	1
7	Float	022912	022523	022523	1
8	Pump End	021713	022999	023000	1
9	Motor 230V	022985	022517	022986	1
10	Locknut - SS 5/16-24	127021	127021	127021	4
11	100 ft. power cord	022516	022516	022516	1
12	Eye Bolt - SS 1/4-20 x 2-1/2	*	*	*	2
12A	Bolt - SS - 1/4 - 20	*	*	*	2
13	Locknut - SS 1/4--20	*	*	*	2
14	Screen	022913	022913	022694	1
15	Screen Cap	021611	021611	021611	1
16	Strain Relief	021613	021613	021613	1
▲	Warning Decal	021625	021625	021625	2
▲	Splice Kit	022919	022919	022919	1
▲▲	Timer (pump or light)	024622	024622	024622	1
▲▲	GFI	022698	022698	022698	1
▲▲	Contactar	022902	022902	022902	1

(*) Standard hardware item, available locally

(▲) Not Shown

(▲▲) In control center

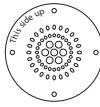
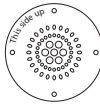
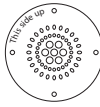
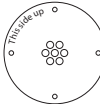
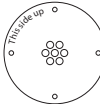
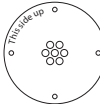
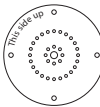
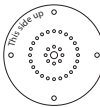
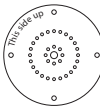
Flow (GPH)	Spray Height (Ft.)	Pattern Image	Pattern Name
1/2 HP 4900	15		Water Lily - 2C
3/4 HP 5825	22		(Factory Installed)
1 HP - 6150	24		
1/2 HP 3300	15		Sky Cannon - 2B
3/4 HP 4100	35		
1 HP 4200	41		
1/2 HP 2700	13		Water Trumpet - 2A
3/4 HP 3400	20		
1 HP 3600	22		

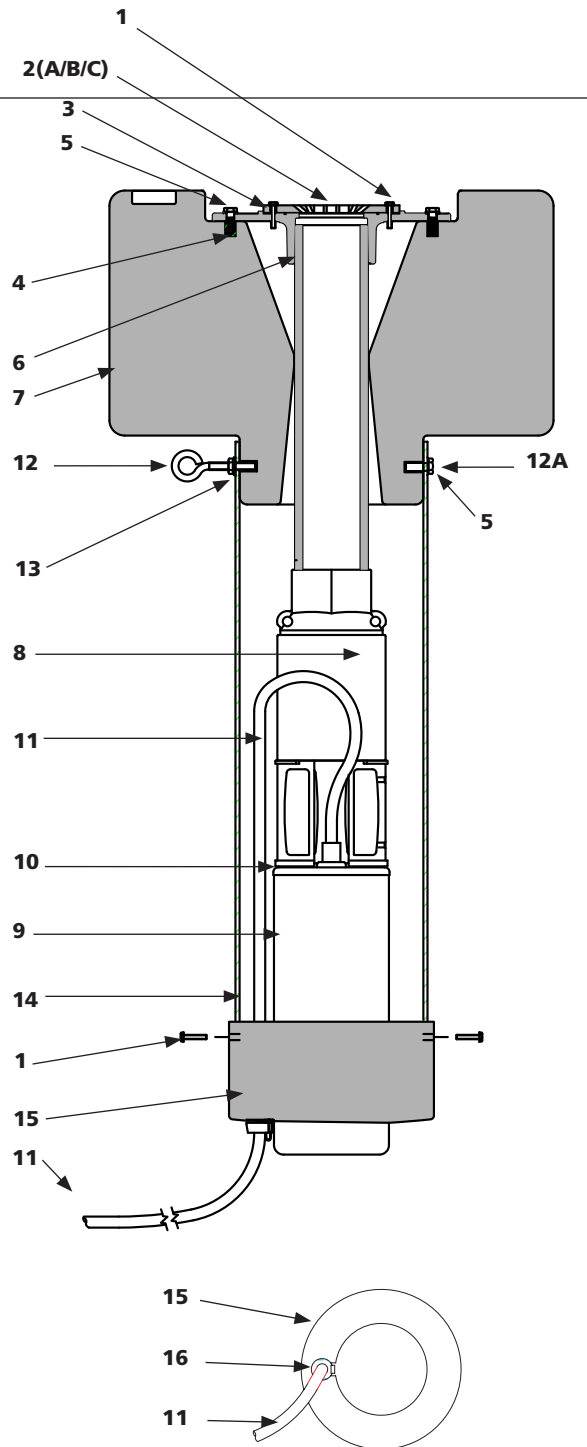

Figure 7 - Parts Illustration for Floating Pond System