

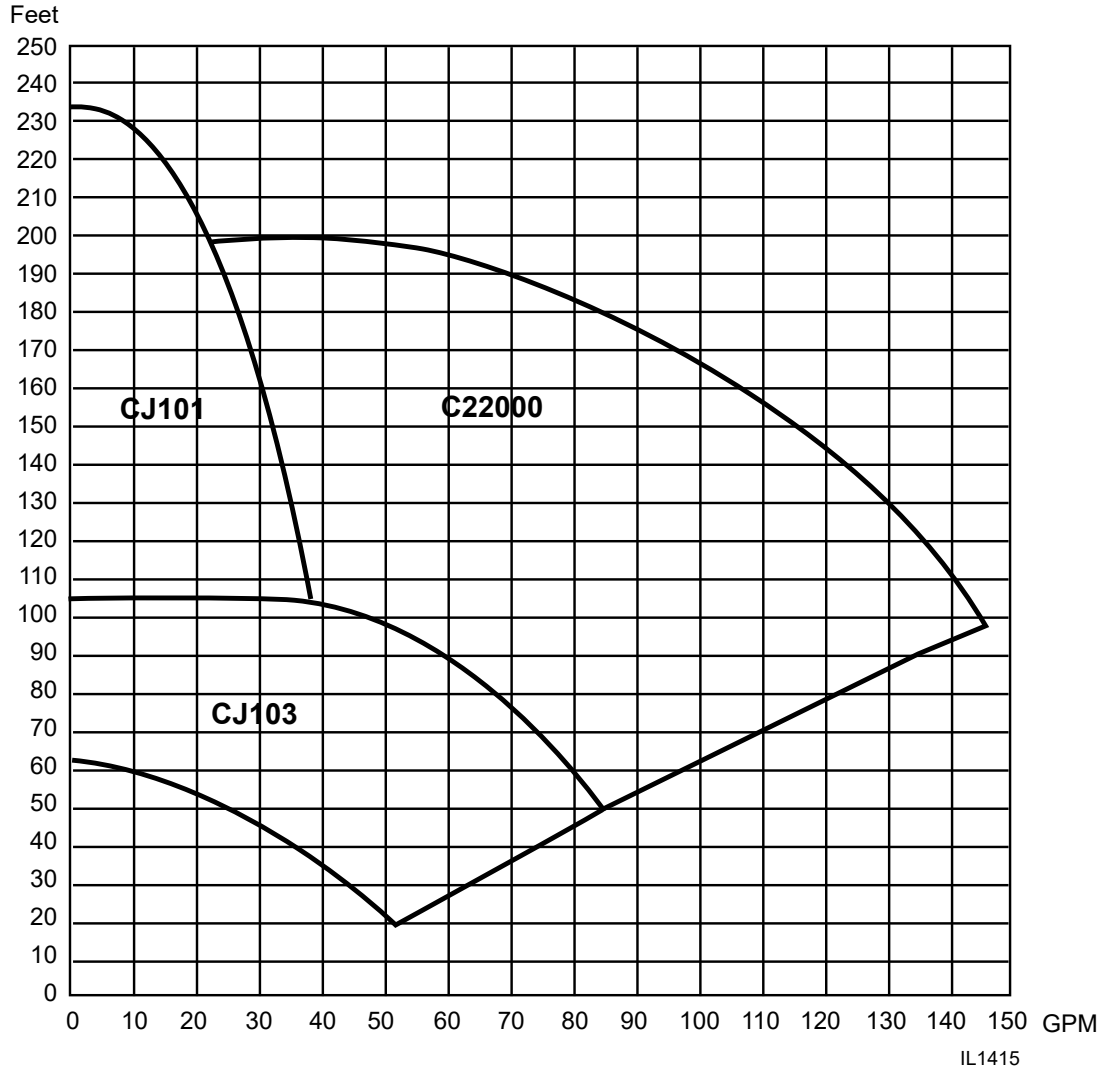

PUMP PERFORMANCE CURVES

FW0190
1120
Supersedes
0120

END SUCTION CENTRIFUGAL COMPOSITE CURVES



INDEX

Pump Series	Page
CJ103	2 - 7
CJ101	8 - 19
C22000	21 - 23
Dimensions	24-25

PUMP PERFORMANCE CURVES



END SUCTION CENTRIFUGALS

CJ10303-1	1/3 HP Single Phase
3450 RPM	60 Hz
Impeller No. 130403	4.06 O.D.
Suction	1-1/2" NPT
Discharge	1-1/4" NPT
Max. Case Pressure,	100 PSI
Liquid	1.0 Sp. Gr.

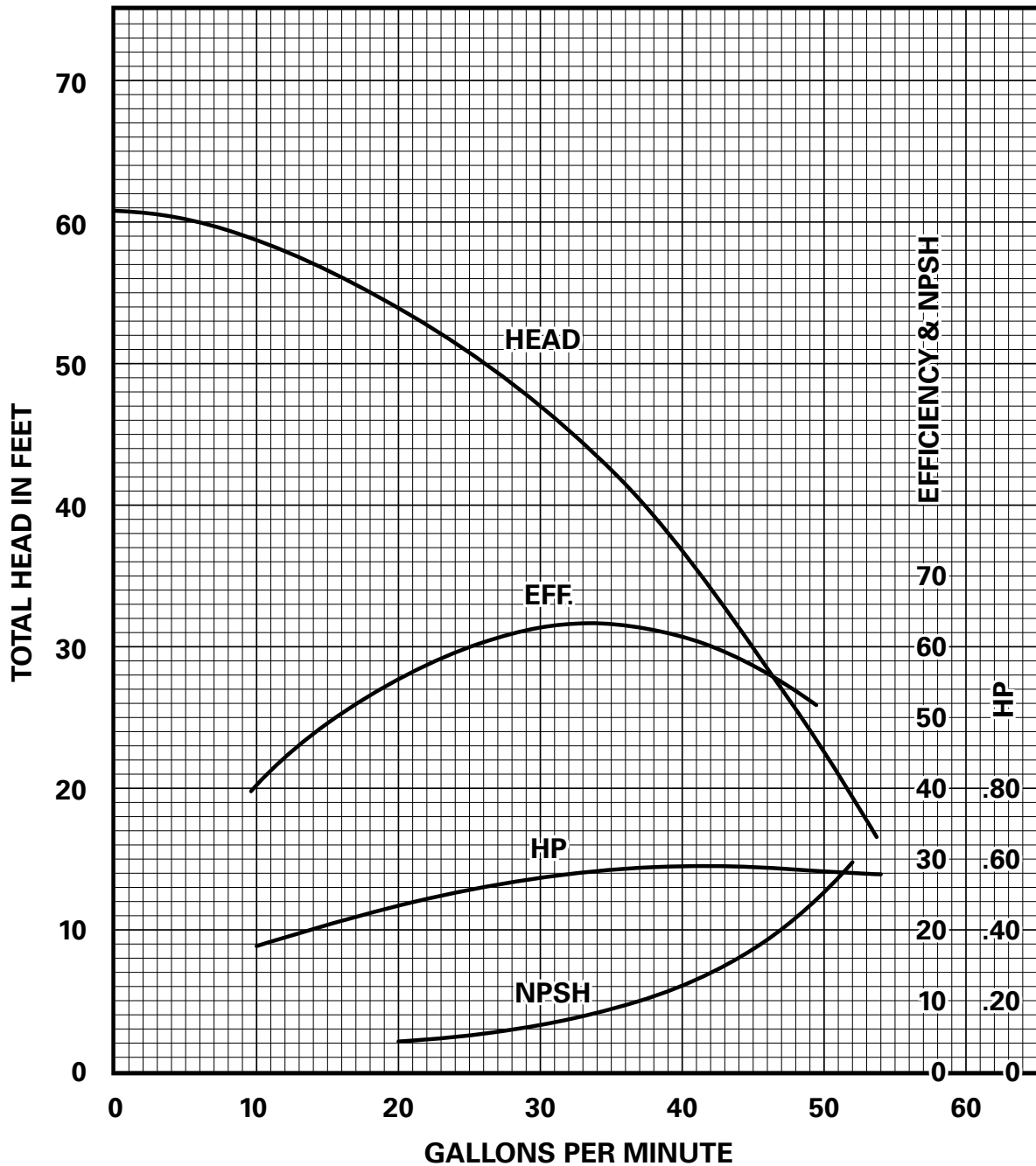



PUMP PERFORMANCE CURVES

END SUCTION CENTRIFUGALS

CJ10305-1	1/2 HP Single Phase
CJ10305-3	1/2 HP Three Phase
3450 RPM	60 Hz
Impeller No. 126900 4.46 O.D.	
Suction	1-1/2" NPT
Discharge	1-1/4" NPT
Max. Case Pressure, 100 PSI	
Liquid 1.0 Sp. Gr.	

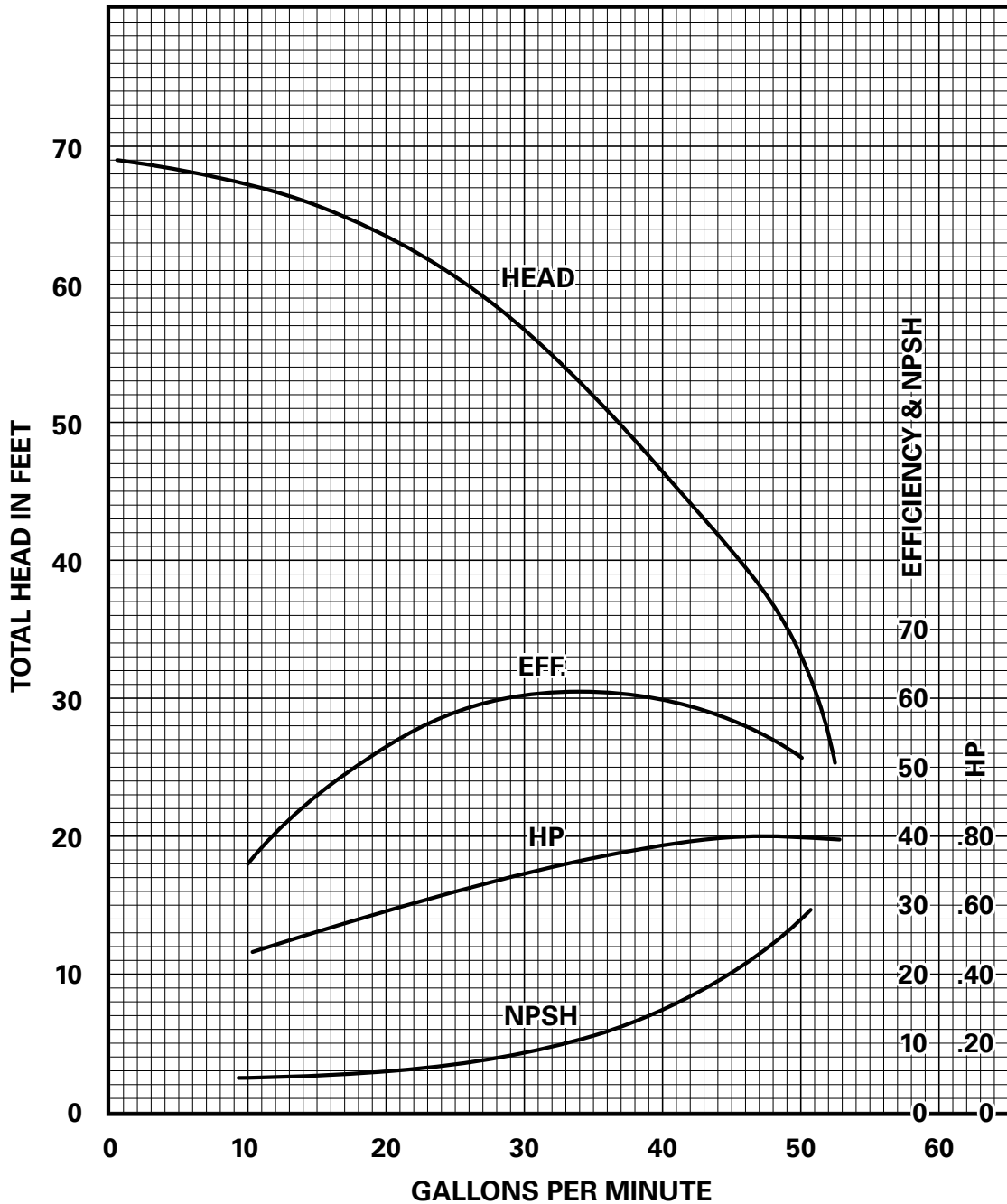

PUMP PERFORMANCE CURVES



END SUCTION CENTRIFUGALS

CJ10307-1	3/4 HP Single Phase
CJ10307-3	3/4 HP Three Phase
3450 RPM	60 Hz
Impeller No. 127805	4.44 O.D.
Suction	1-1/2" NPT
Discharge	1-1/4" NPT
Max. Case Pressure	100 PSI
Liquid	1.0 Sp. Gr.

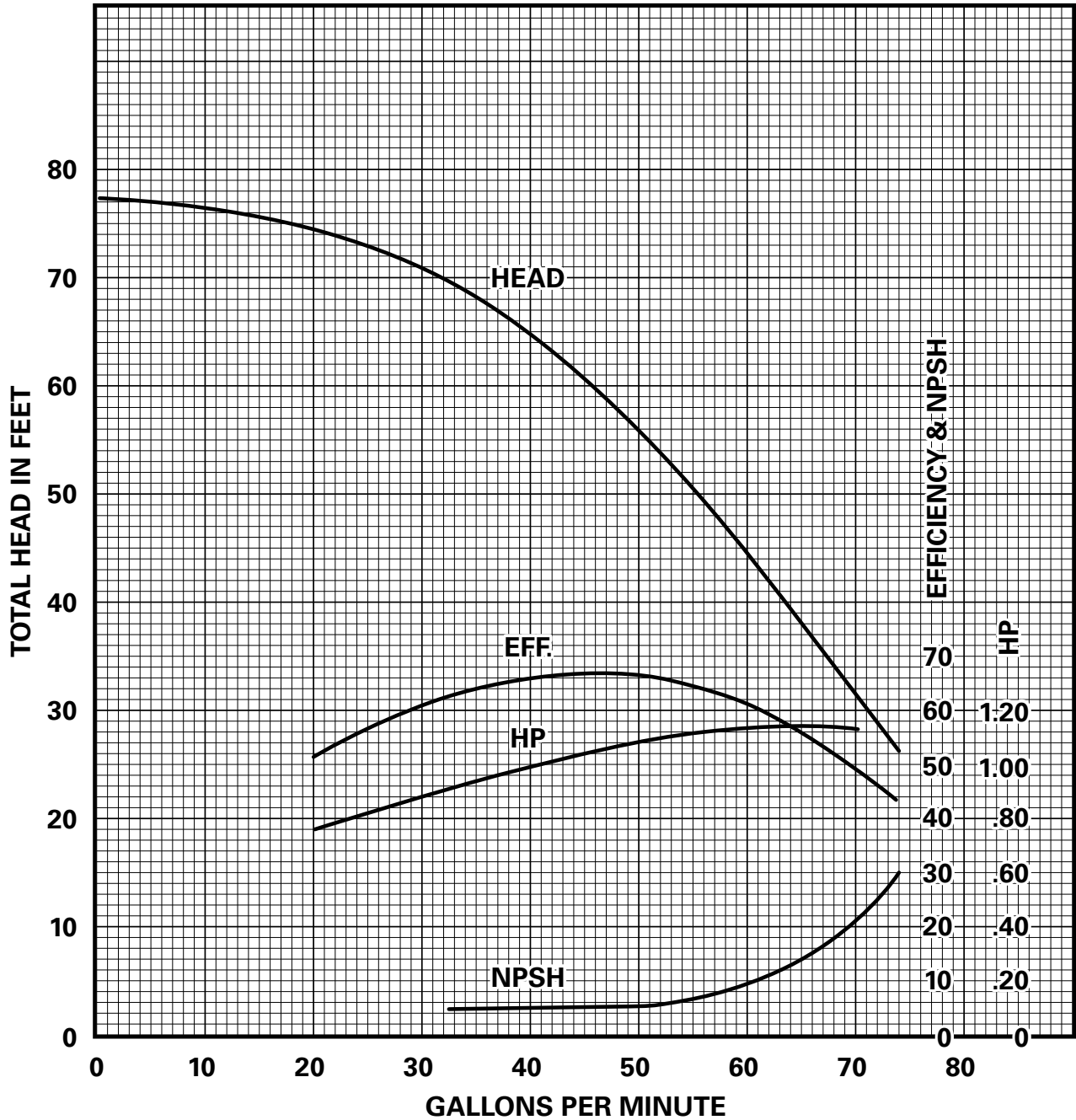



PUMP PERFORMANCE CURVES

END SUCTION CENTRIFUGALS

CJ10310-1	1 HP Single Phase
CJ10310-3	1 HP Three Phase
3450 RPM	60 Hz
Impeller No. 127804 4.87 O.D.	
Suction	1-1/2" NPT
Discharge	1-1/4" NPT
Max. Case Pressure, 100 PSI	
Liquid 1.0 Sp. Gr.	

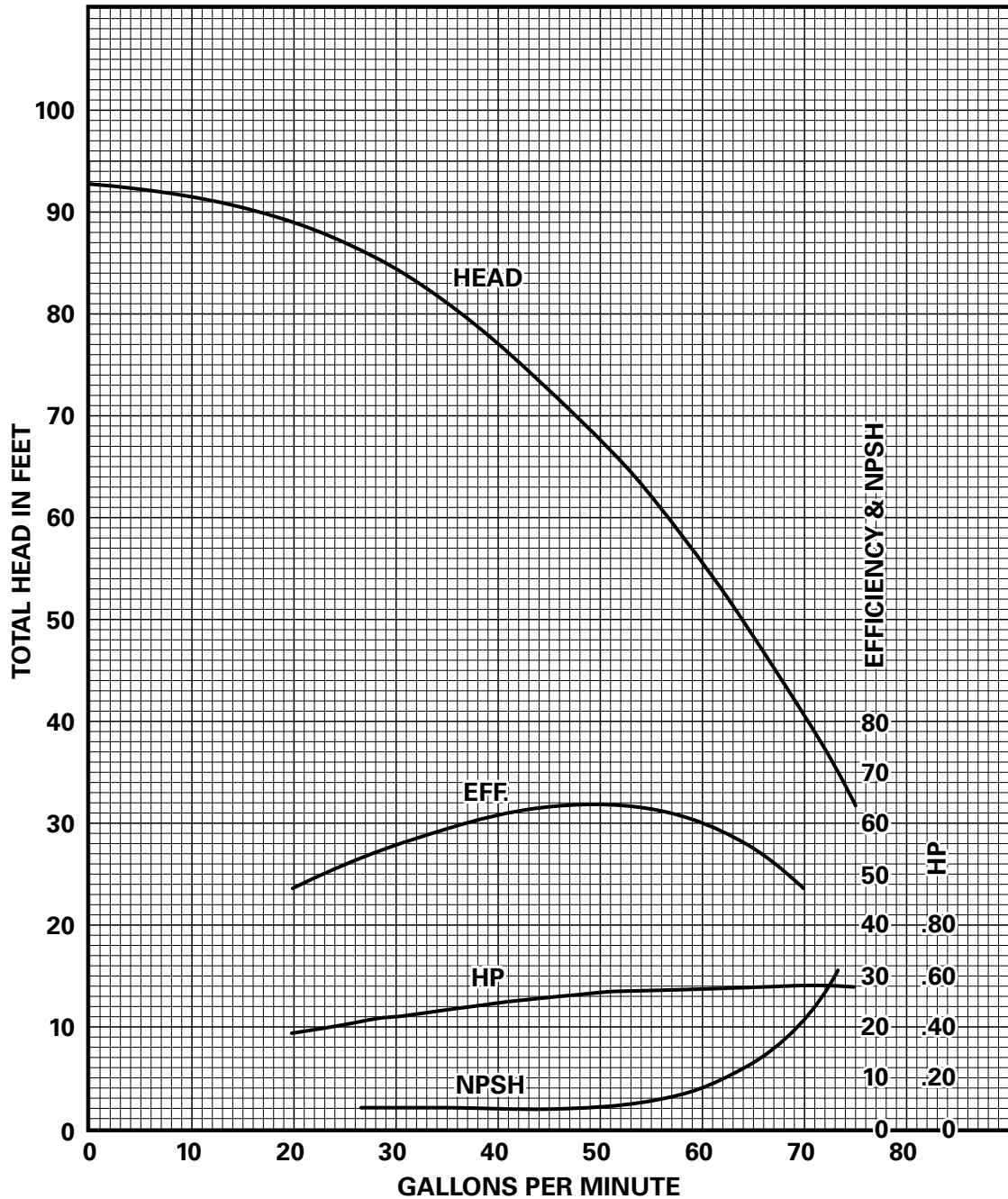

PUMP PERFORMANCE CURVES



END SUCTION CENTRIFUGALS

CJ10315-1	1-1/2 HP Single Phase
CJ10315-3	1-1/2 HP Three Phase
3450 RPM	60 HZ
Impeller No. 127806	5.09 O.D.
Suction	1-1/2" NPT
Discharge	1-1/4" NPT
Max. Case Pressure,	100 PSI
Liquid	1.0 Sp. Gr.

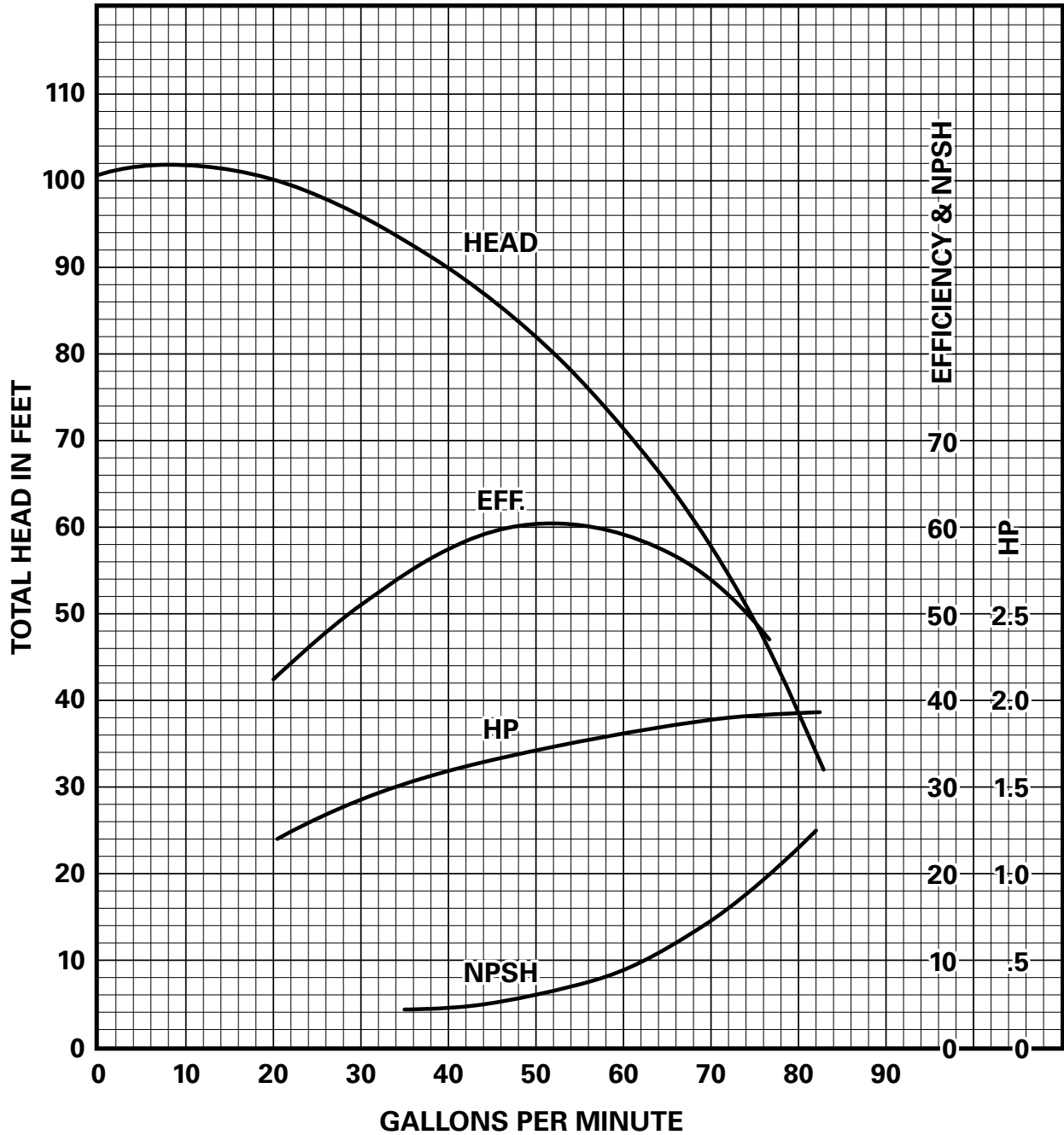



PUMP PERFORMANCE CURVES

END SUCTION CENTRIFUGALS

CJ10320-1	3 HP Single Phase
CJ10320-3	2 HP Three Phase
3450 RPM	60 Hz
Impeller No. 127848	5.09 O.D.
Suction	1-1/2" NPT
Discharge	1-1/4" NPT
Max. Case Pressure,	100 PSI
Liquid	1.0 Sp. Gr.

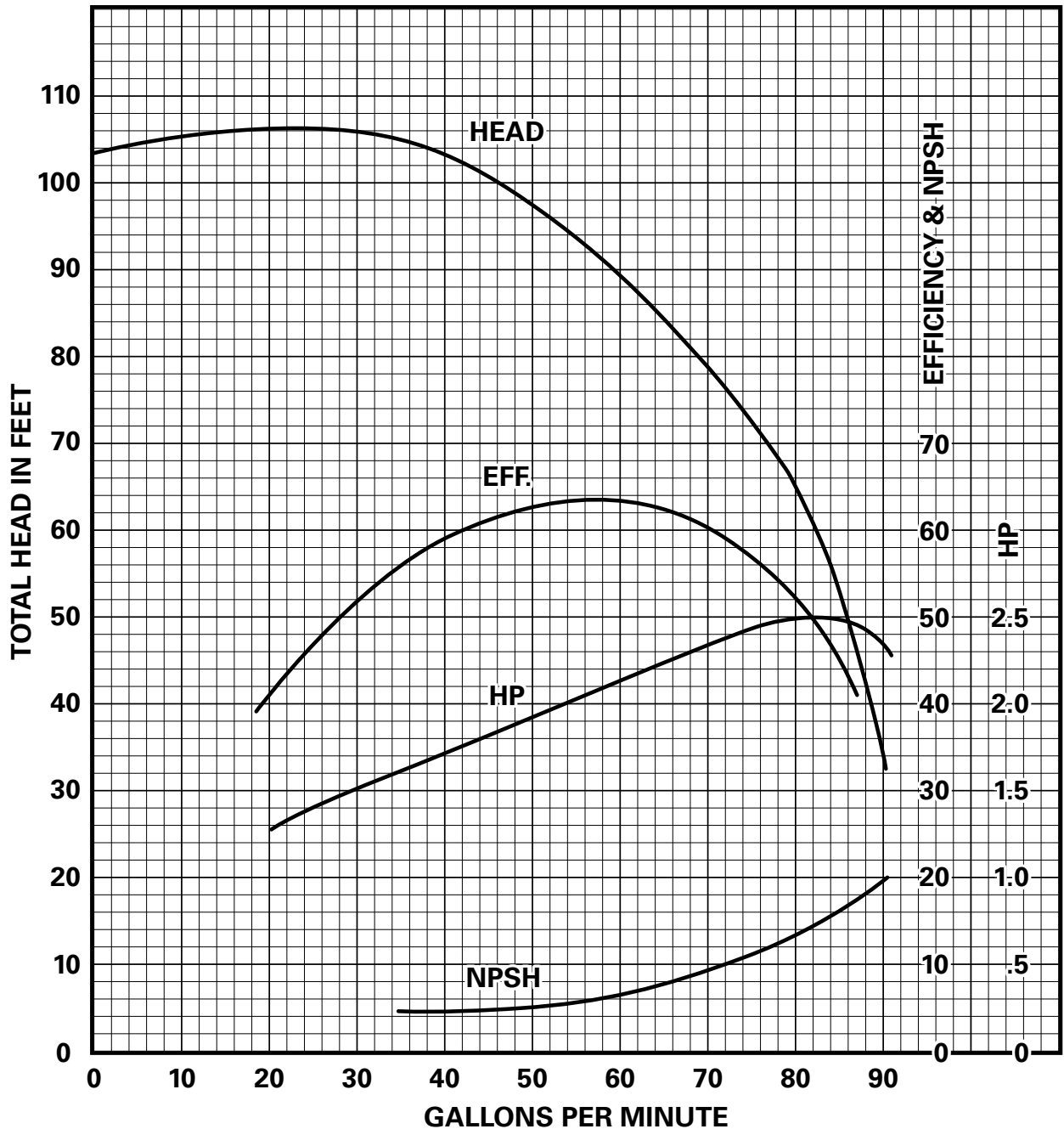

PUMP PERFORMANCE CURVES



END SUCTION CENTRIFUGALS

CJ101B07-1 3/4 HP Single Phase
CJ101B07-3 3/4 HP Three Phase
3450 RPM 60 Hz
Impeller No. 135280 4.000 O.D. Brass
Two Stage
Suction 1-1/2" NPT
Discharge 1-1/4" NPT
Max. Case Pressure, 160 PSI
Liquid 1.0 Sp. Gr.

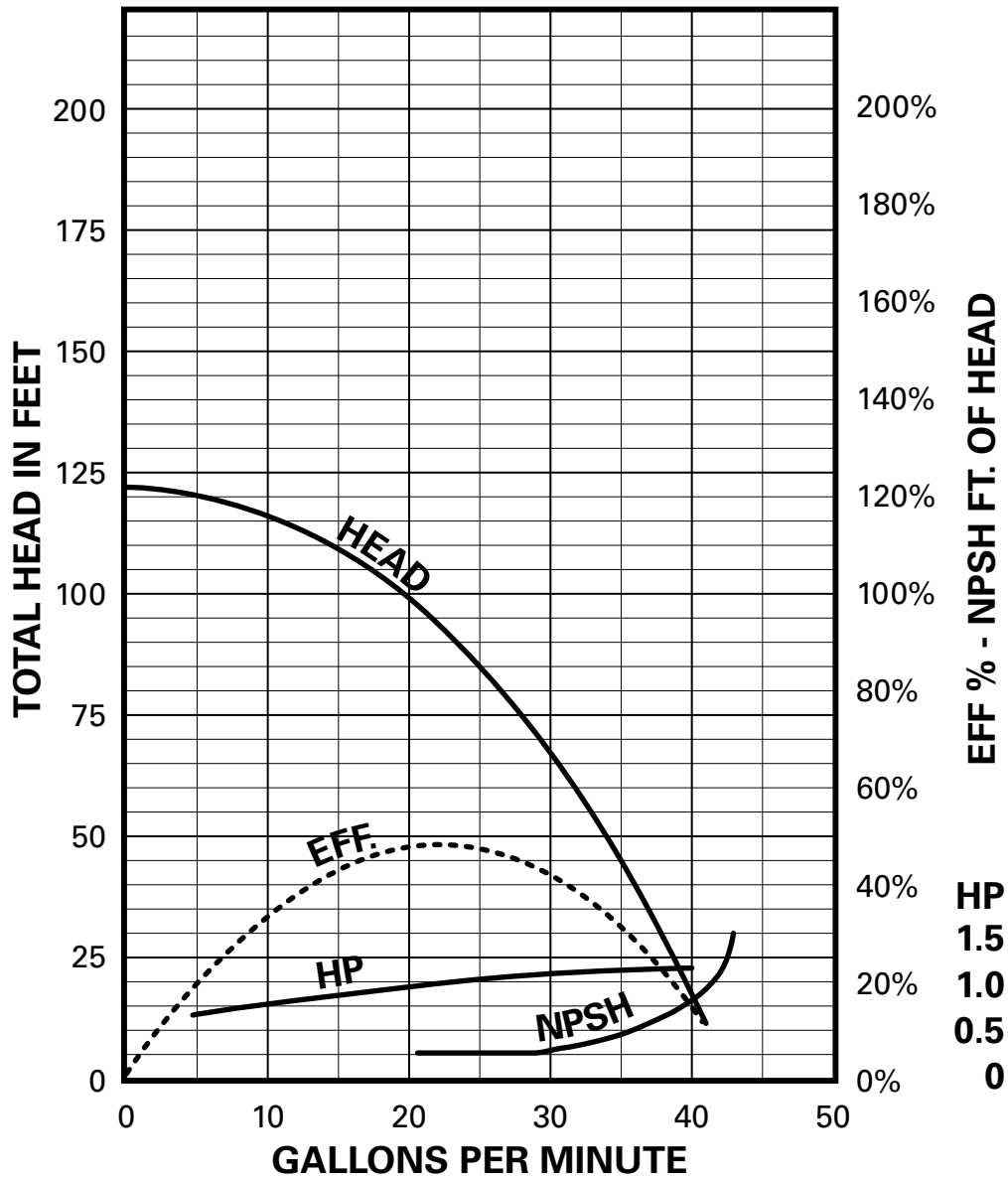



PUMP PERFORMANCE CURVES

END SUCTION CENTRIFUGALS

CJ101B10-1	1 HP Single Phase
CJ101B10-3	1 HP Three Phase
3450 RPM	60 Hz
Impeller No. 135281 4.25 O.D. Brass	
Two Stage	
Suction	1-1/2" NPT
Discharge	1-1/4" NPT
Max. Case Pressure, 160 PSI	
Liquid 1.0 Sp. Gr.	

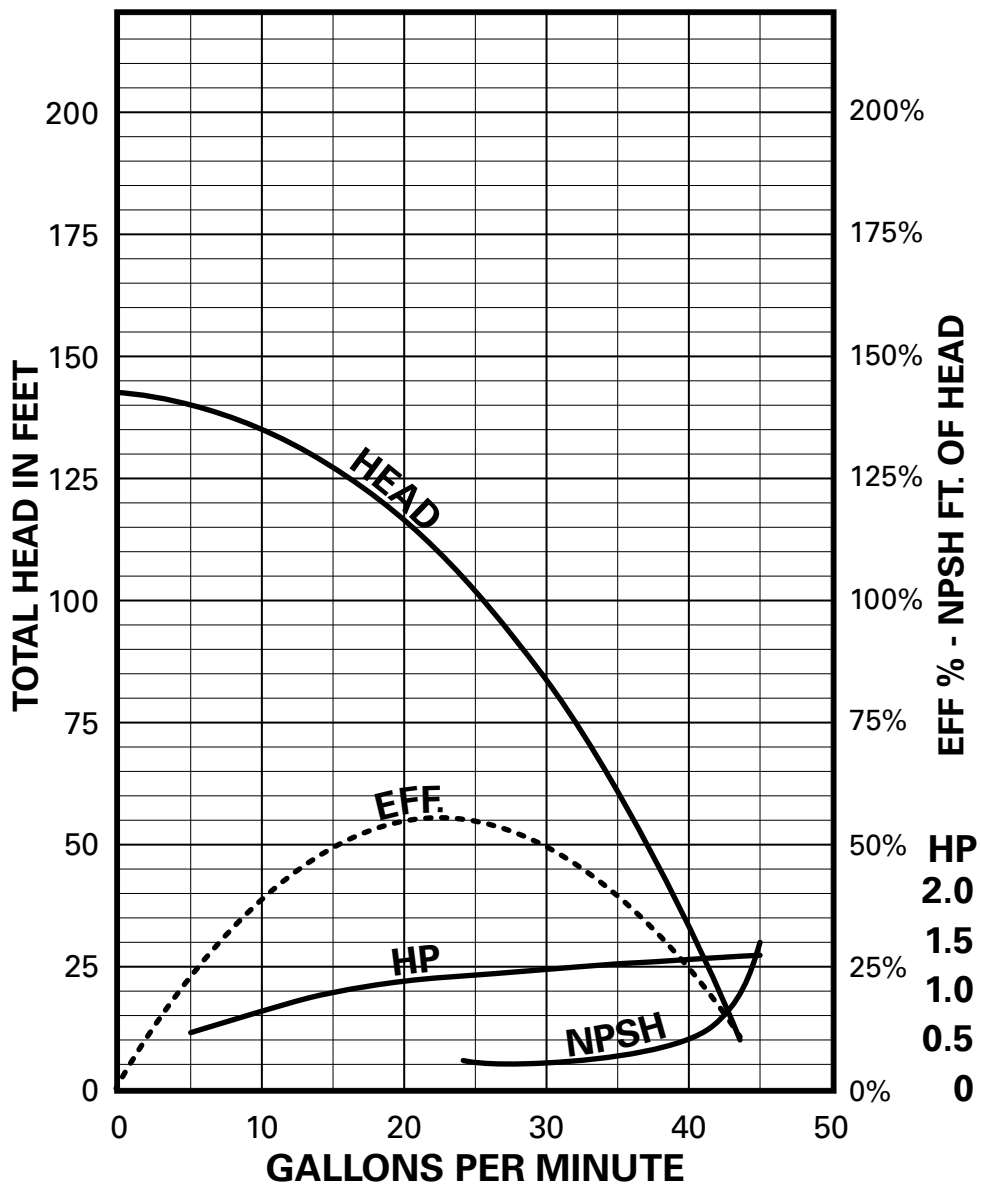

PUMP PERFORMANCE CURVES



END SUCTION CENTRIFUGALS

CJ101B15-1	1-1/2 HP Single Phase
CJ101B15-3	1-1/2 HP Three Phase
3450 RPM	60 Hz
Impeller No. 126900 4.47 O.D. Brass	
Two Stage	
Suction	1-1/2" NPT
Discharge	1-1/4" NPT
Max. Case Pressure, 160 PSI	
Liquid 1.0 Sp. Gr.	

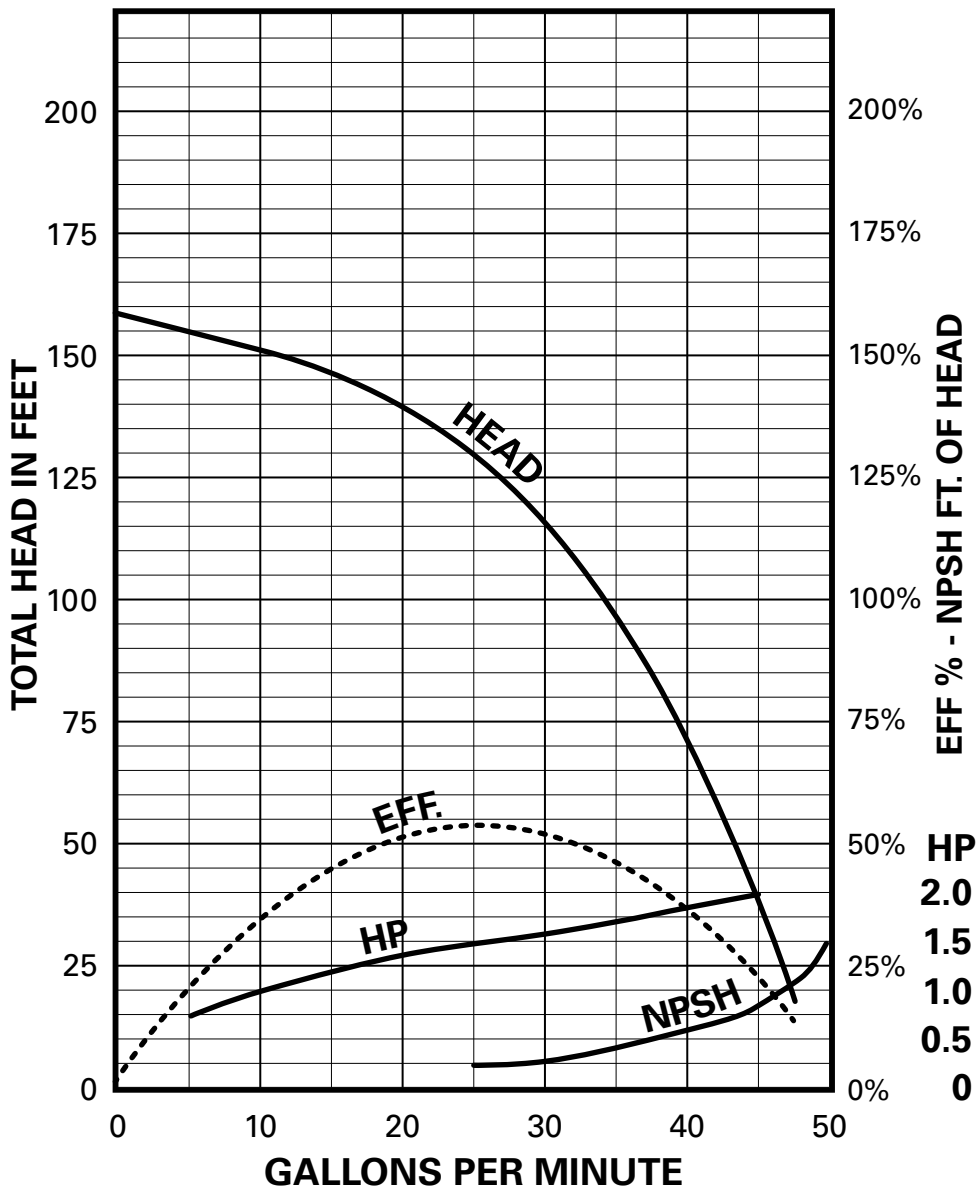



PUMP PERFORMANCE CURVES

END SUCTION CENTRIFUGALS

CJ101B20-1 2 HP Single Phase
CJ101B20-3 2 HP Three Phase
3450 RPM 60 Hz
Impeller No. 126901 4.47 O.D. Brass
Two Stage
Suction 1-1/2" NPT
Discharge 1-1/4" NPT
Max. Case Pressure, 160 PSI
Liquid 1.0 Sp. Gr.

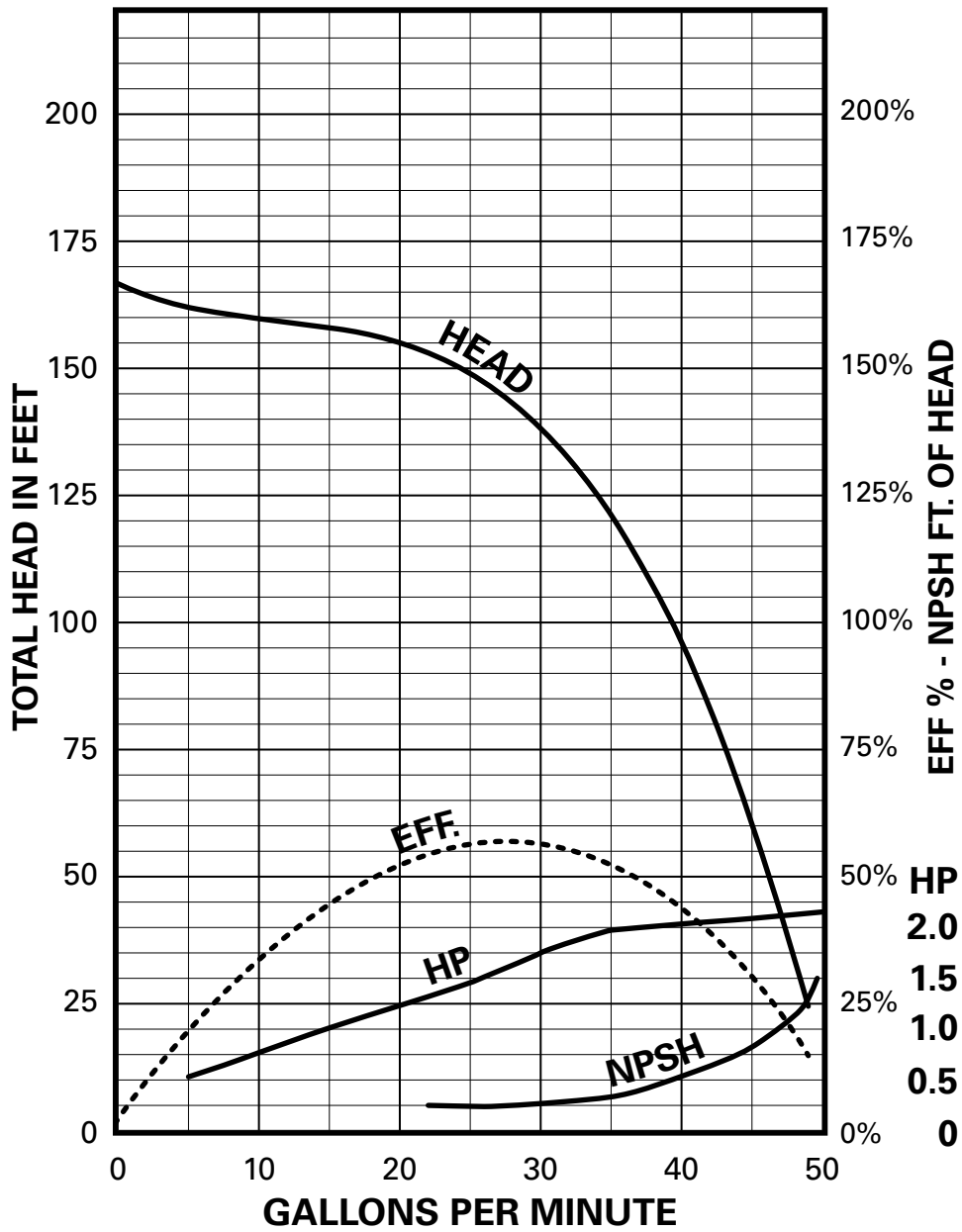

PUMP PERFORMANCE CURVES



FLINT & WALLING

END SUCTION CENTRIFUGALS

CJ101C20-1 2 HP Single Phase
CJ101C20-3 2 HP Three Phase
3450 RPM 60 Hz
Impeller No. 139126 4.34 O.D. Brass
Three Stage
Suction 1-1/2" NPT
Discharge 1-1/4" NPT
Max. Case Pressure, 160 PSI
Liquid 1.0 Sp. Gr.

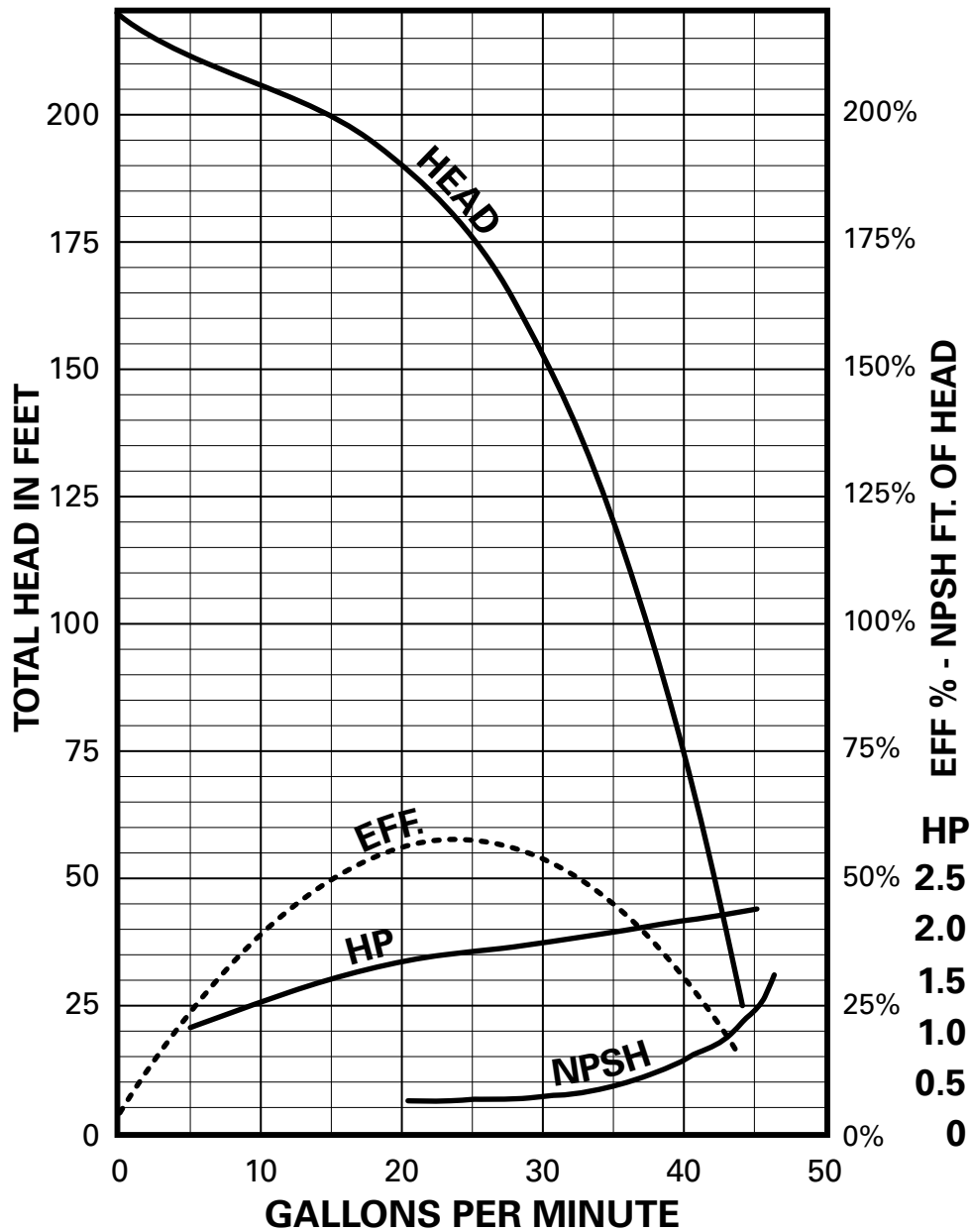



PUMP PERFORMANCE CURVES

END SUCTION CENTRIFUGALS

CJ101C30-1 3 HP Single Phase
CJ101C30-3 3 HP Three Phase
3450 RPM 60 Hz
Impeller No. 136951 4.25 O.D. Brass
Three Stage
Suction 1-1/2" NPT
Discharge 1-1/4" NPT
Max. Case Pressure, 160 PSI
Liquid 1.0 Sp. Gr.

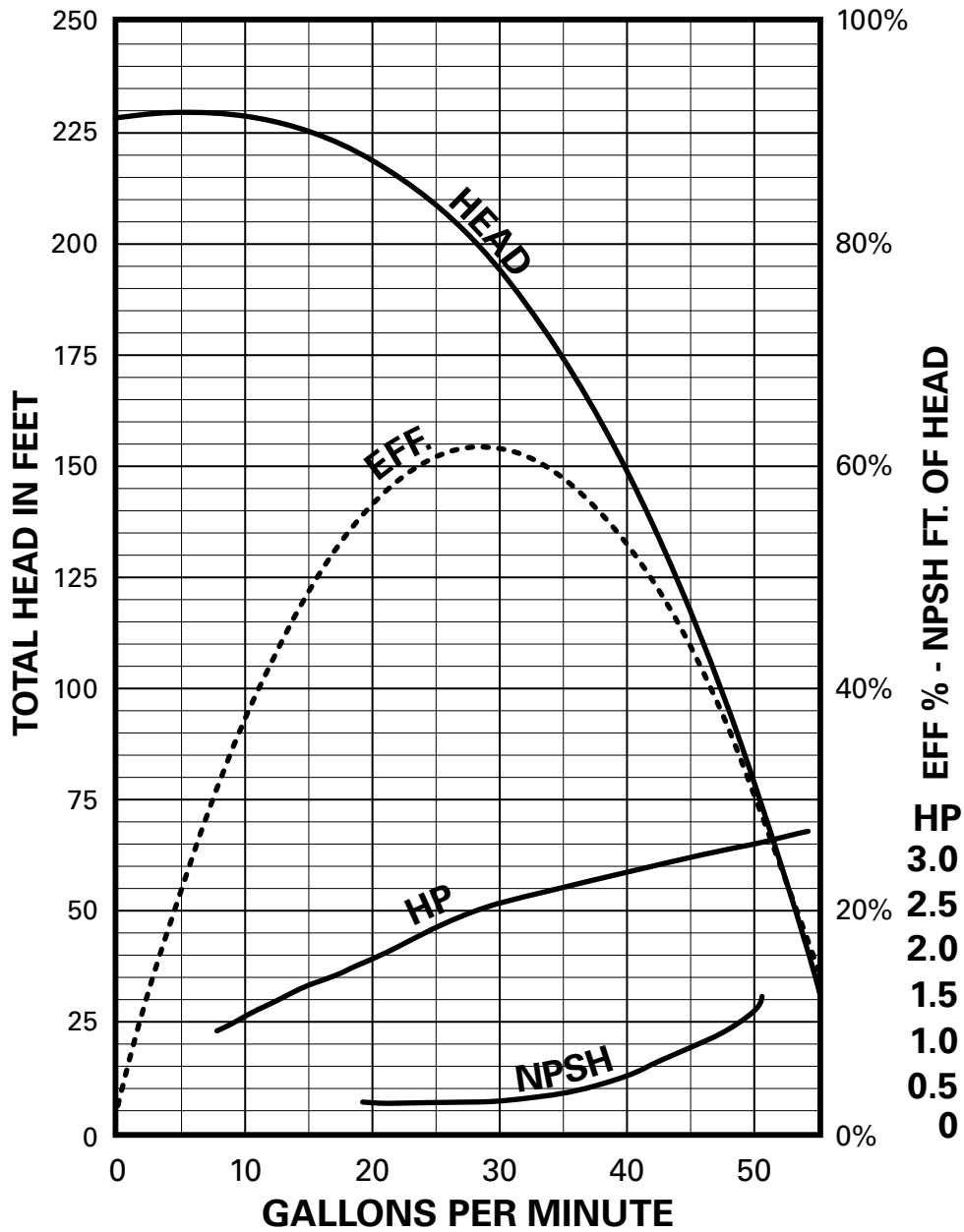

PUMP PERFORMANCE CURVES



FLINT & WALLING

END SUCTION CENTRIFUGALS

CJ101P07-1	3/4 HP Single Phase
CJ101P07-3	3/4 HP Three Phase
3450 RPM	60 Hz
Impeller No. 133425 3.87 O.D. Celcon	
Two Stage	
Suction	1-1/2" NPT
Discharge	1-1/4" NPT
Max. Case Pressure, 160 PSI	
Liquid 1.0 Sp. Gr.	

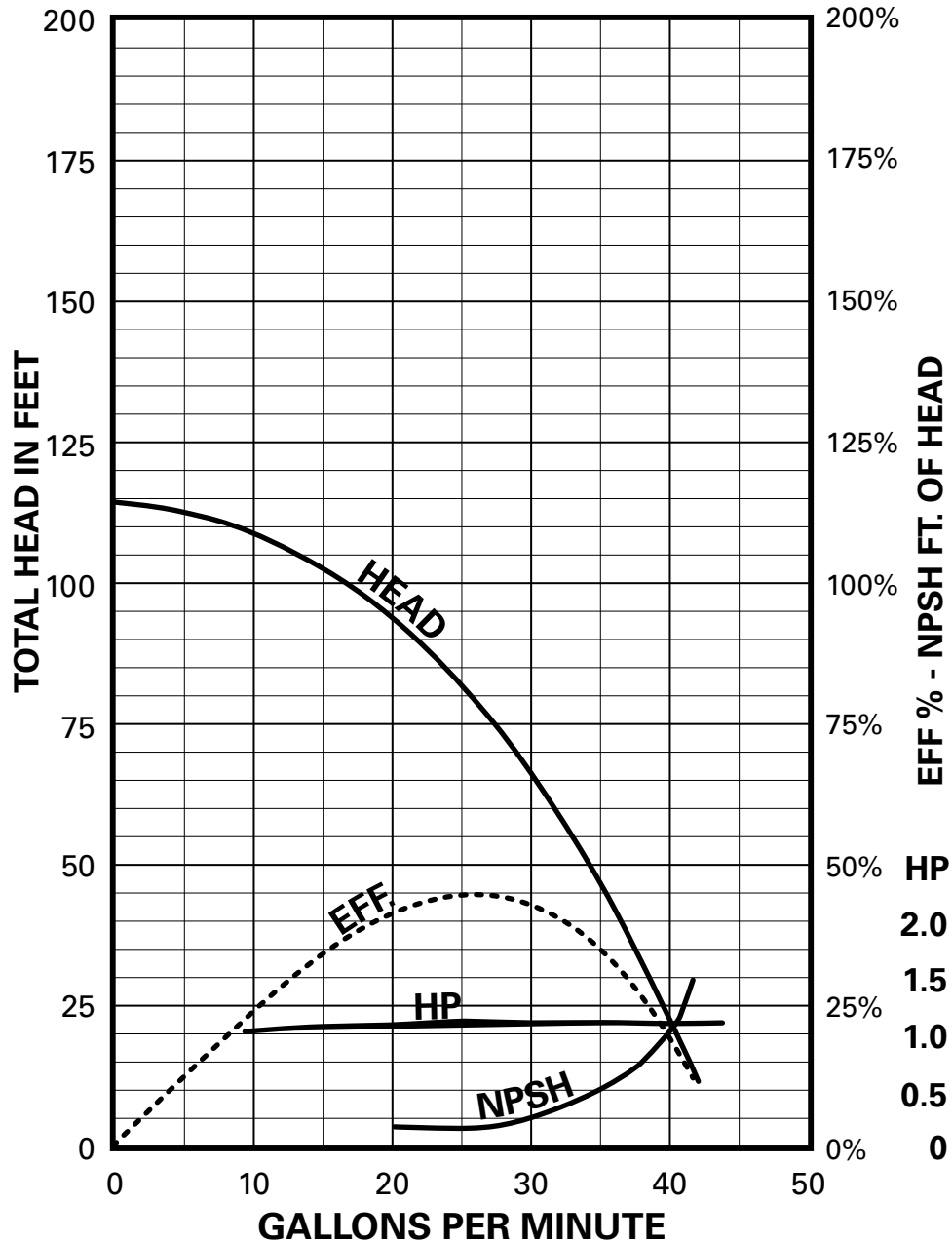



PUMP PERFORMANCE CURVES

END SUCTION CENTRIFUGALS

CJ101P10-1 1 HP Single Phase
CJ101P10-3 1 HP Three Phase
3450 RPM 60 Hz
Impeller No. 133427 4.28 O.D. Celcon
Two Stage
Suction 1-1/2" NPT
Discharge 1-1/4" NPT
Max. Case Pressure, 160 PSI
Liquid 1.0 Sp. Gr.

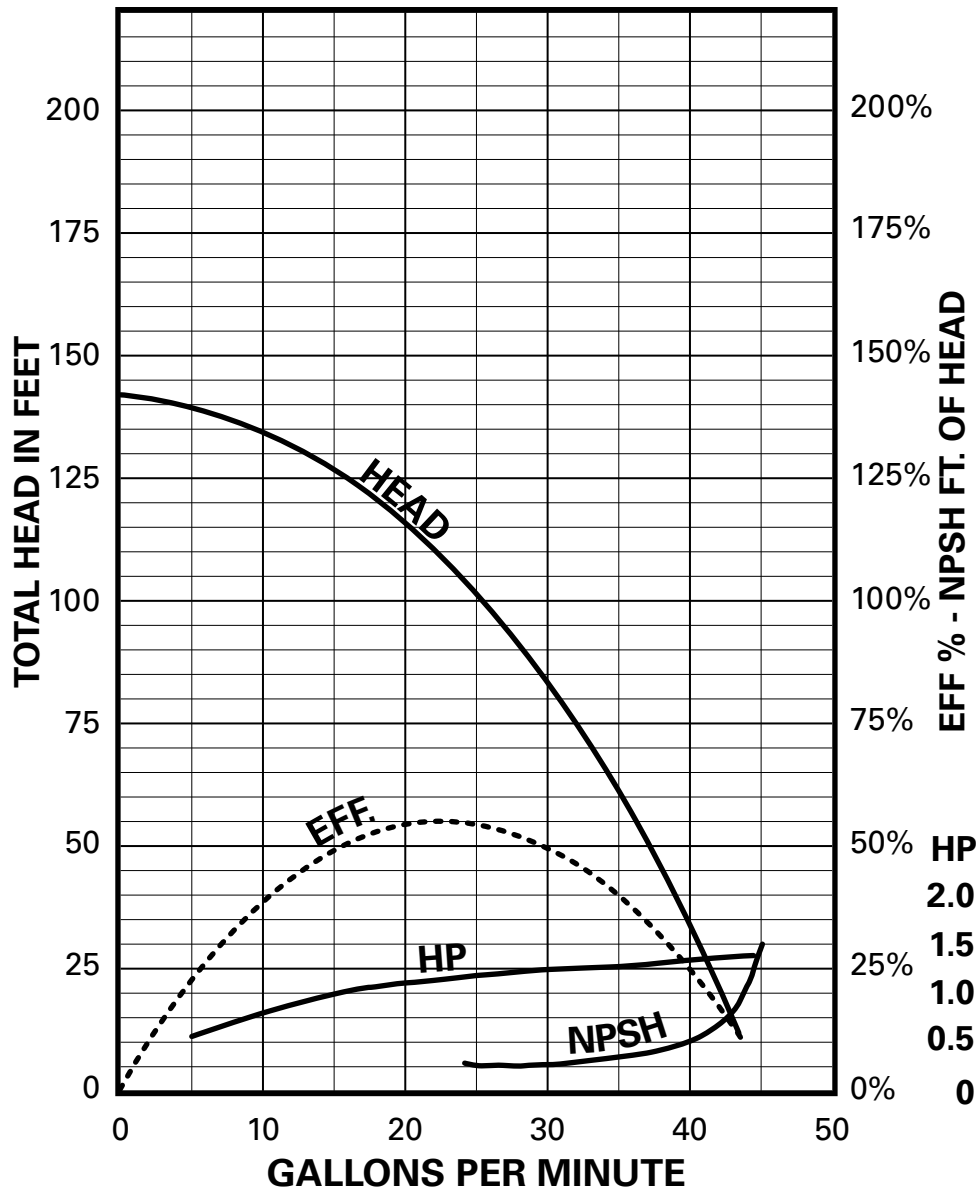

PUMP PERFORMANCE CURVES



END SUCTION CENTRIFUGALS

CJ101P15-1 1-1/2 HP Single Phase
CJ101P15-3 1-1/2 HP Three Phase
3450 RPM 60 Hz
Impeller No. 139180 4.20 O.D. Celcon
Two Stage
Suction 1-1/2" NPT
Discharge 1-1/4" NPT
Max. Case Pressure, 160 PSI
Liquid 1.0 Sp. Gr.

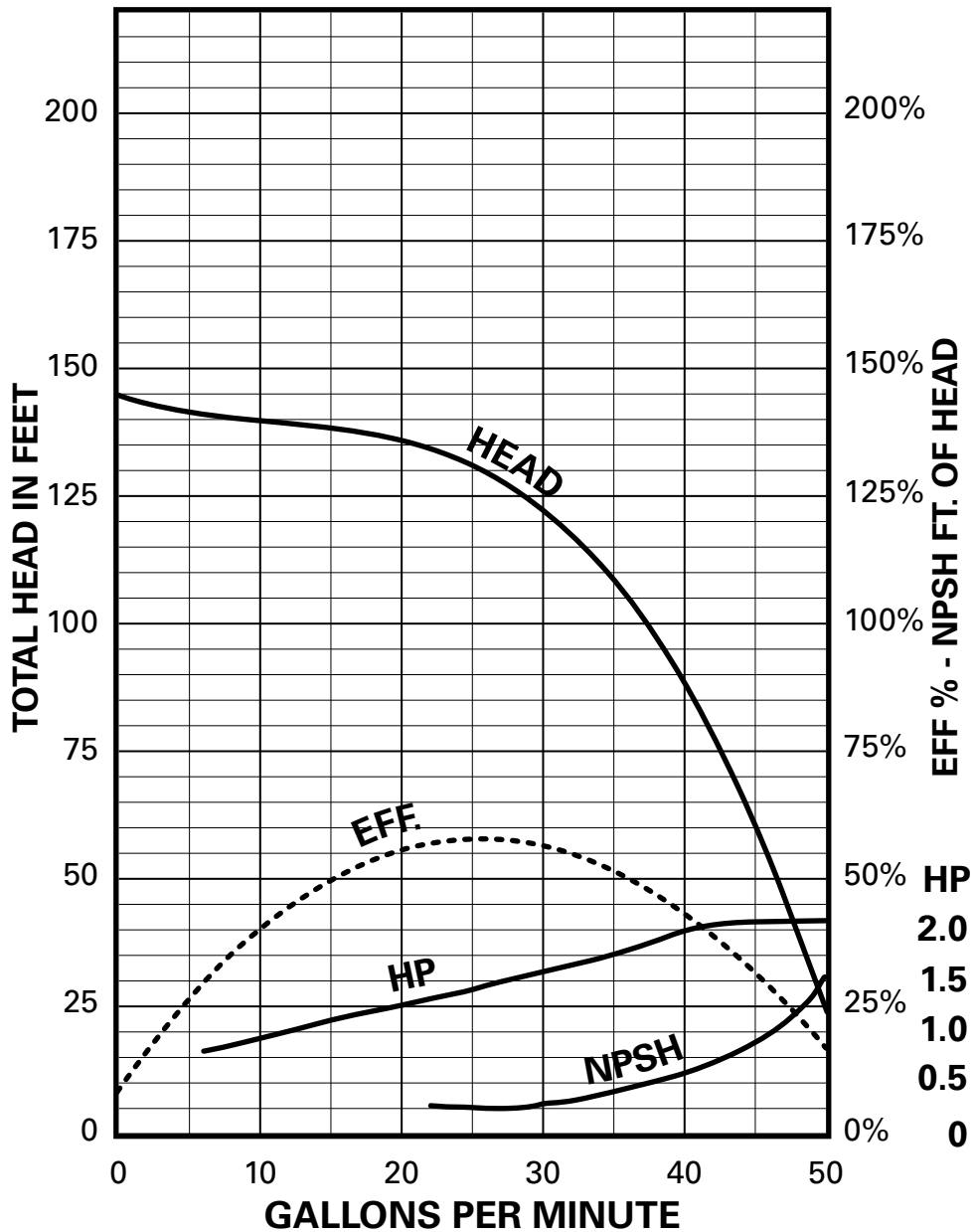



PUMP PERFORMANCE CURVES

END SUCTION CENTRIFUGALS

CJ101P20-1	2.0 HP Single Phase
CJ101P20-3	2.0 HP Three Phase
3450 RPM	60 Hz
Impeller No. 128472	4.44 O.D. Celcon
Two Stage	
Suction	1-1/2" NPT
Discharge	1-1/4" NPT
Max. Case Pressure, 160 PSI	
Liquid 1.0 Sp. Gr.	

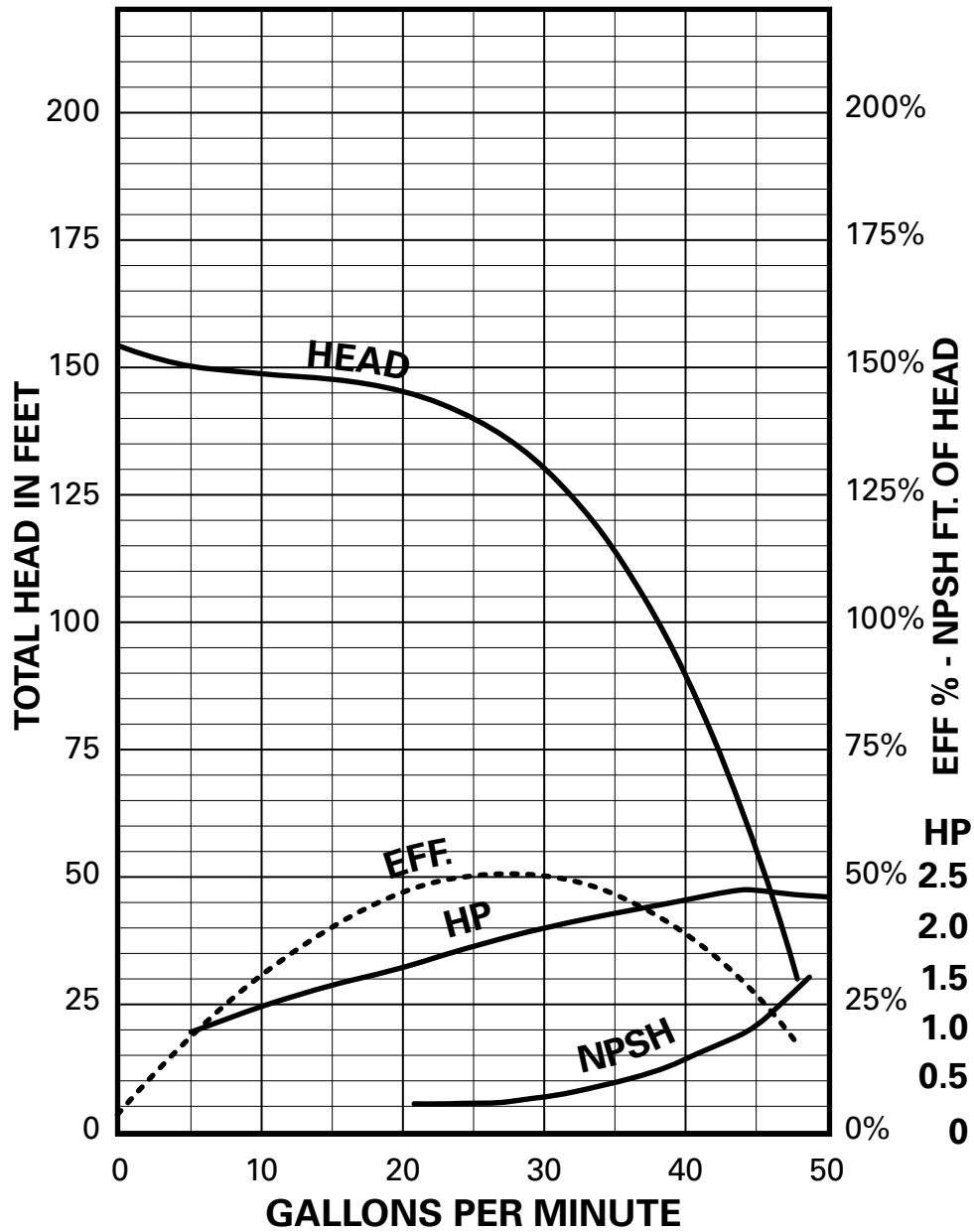

PUMP PERFORMANCE CURVES



END SUCTION CENTRIFUGALS

CJ101D20-1 2 HP Single Phase
CJ101D20-3 2 HP Three Phase
3450 RPM 60 Hz
Impeller No. 133427 4.28 O.D. Celcon
Three Stage
Suction 1-1/2" NPT
Discharge 1-1/4" NPT
Max. Case Pressure, 160 PSI
Liquid 1.0 Sp. Gr.

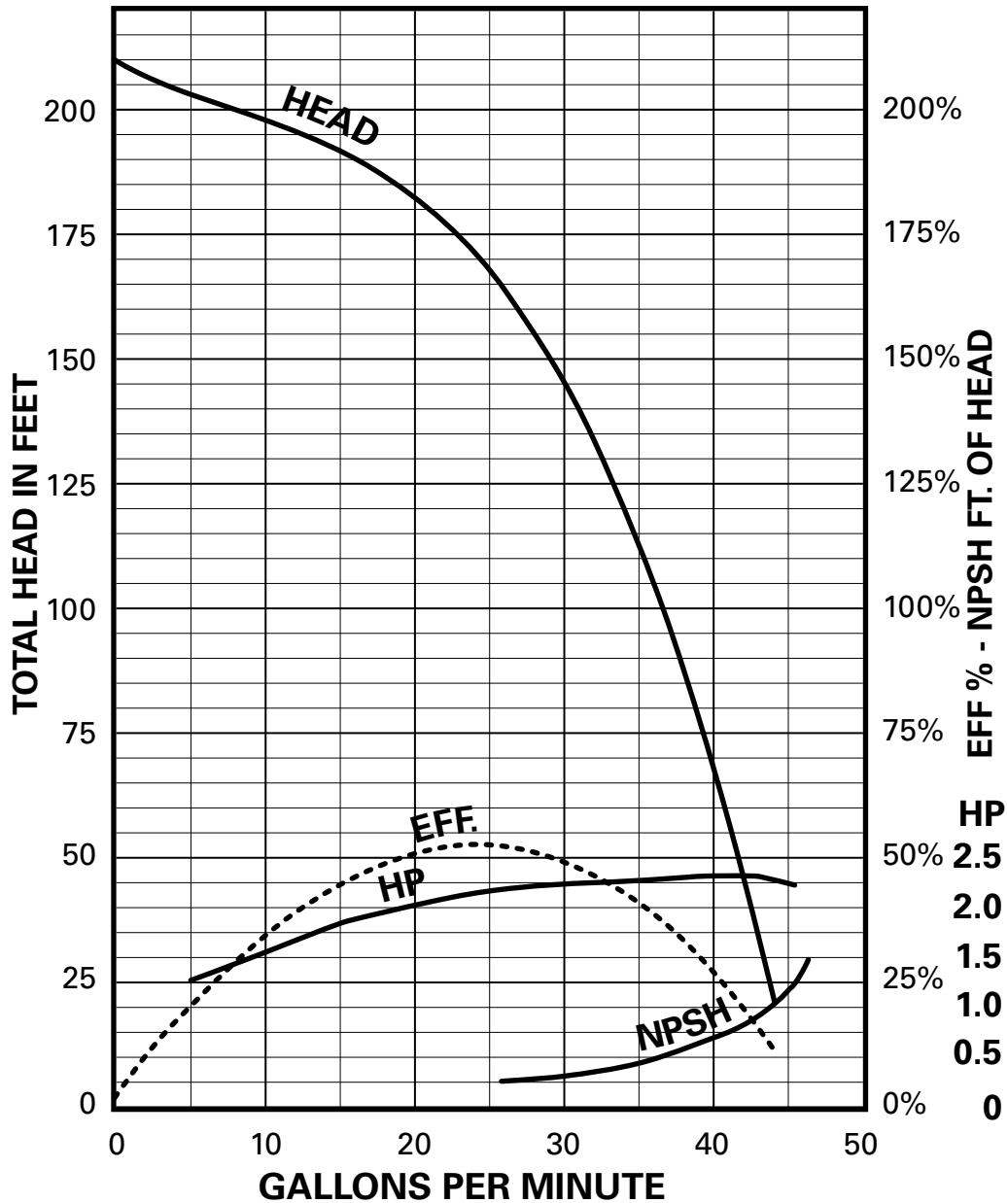



PUMP PERFORMANCE CURVES

END SUCTION CENTRIFUGALS

CJ101D30-1 3 HP Single Phase
CJ101D30-3 3 HP Three Phase
3450 RPM 60 Hz
Impeller No. 139104 4.25 O.D. Celcon
Three Stage
Suction 1-1/2" NPT
Discharge 1-1/4" NPT
Max. Case Pressure, 160 PSI
Liquid 1.- Sp. Gr.

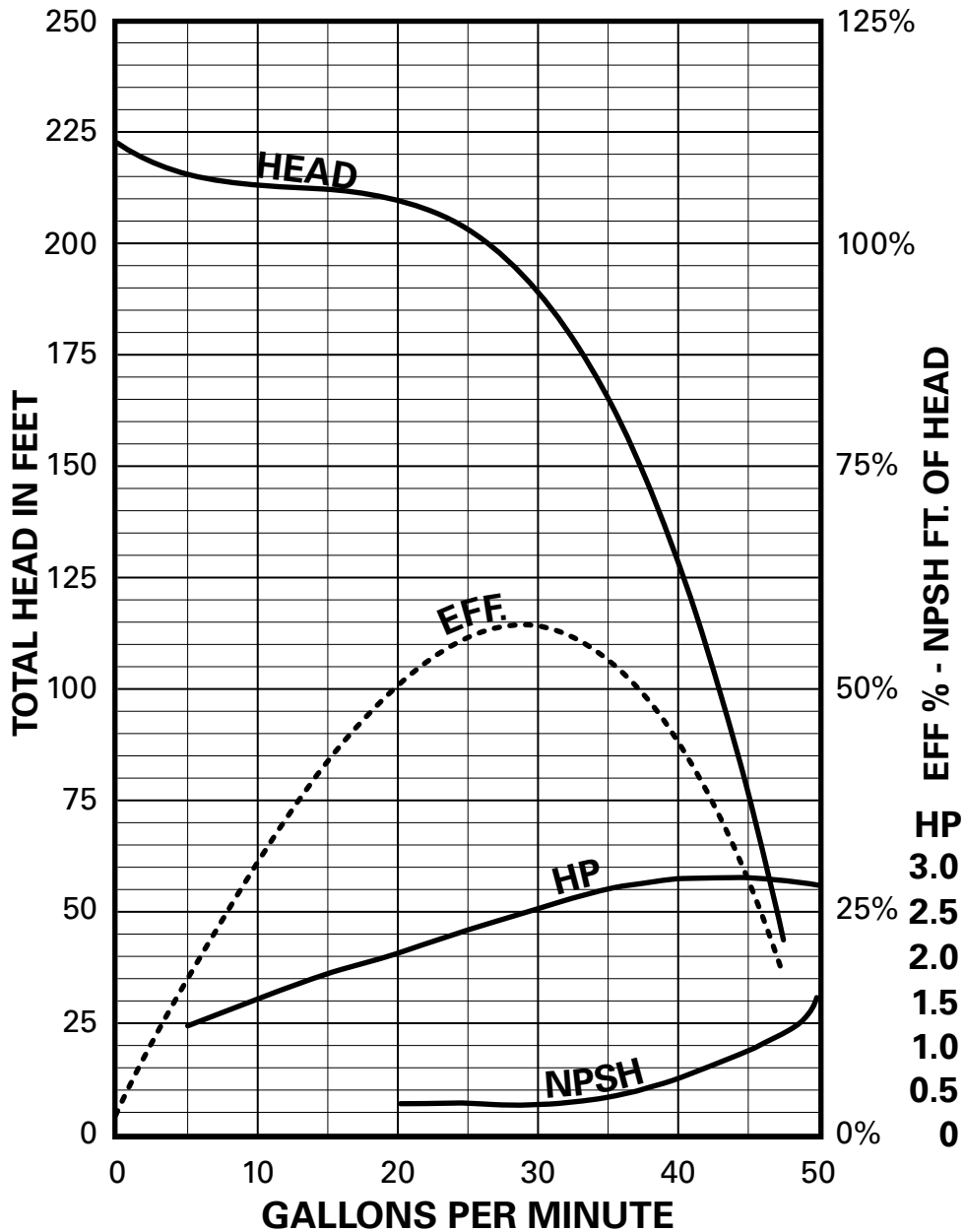

PUMP PERFORMANCE CURVES



END SUCTION CENTRIFUGALS

C22231	3 HP Single Phase
C22233	3 HP Three Phase
3450 RPM	60 Hz
Two Stage	
Impeller No. 134973 & 134980 5.185 O.D.	
Suction	3" NPT
Discharge	2" NPT
Max. Case Pressure, 120 PSI	
Liquid 1.0 Sp. Gr.	

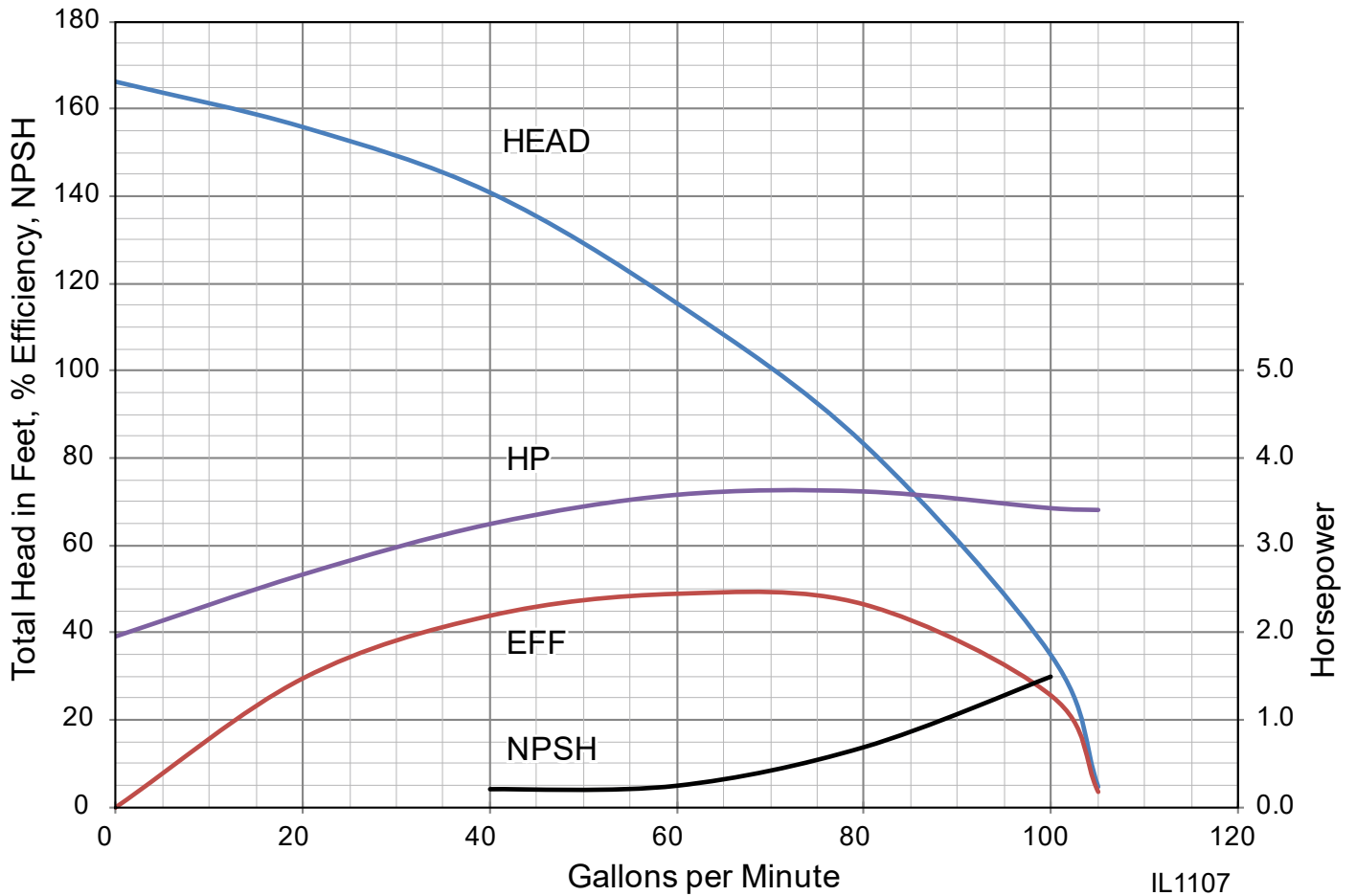



PUMP PERFORMANCE CURVES

END SUCTION CENTRIFUGALS

C22251	5 HP Single Phase
C22253	5 HP Three Phase
3450 RPM	60 Hz
Two Stage	
Impeller No. 134974 & 134981 4.950 O.D.	
Suction	3" NPT
Discharge	2" NPT
Max. Case Pressure, 120 PSI	
Liquid 1.0 Sp. Gr.	

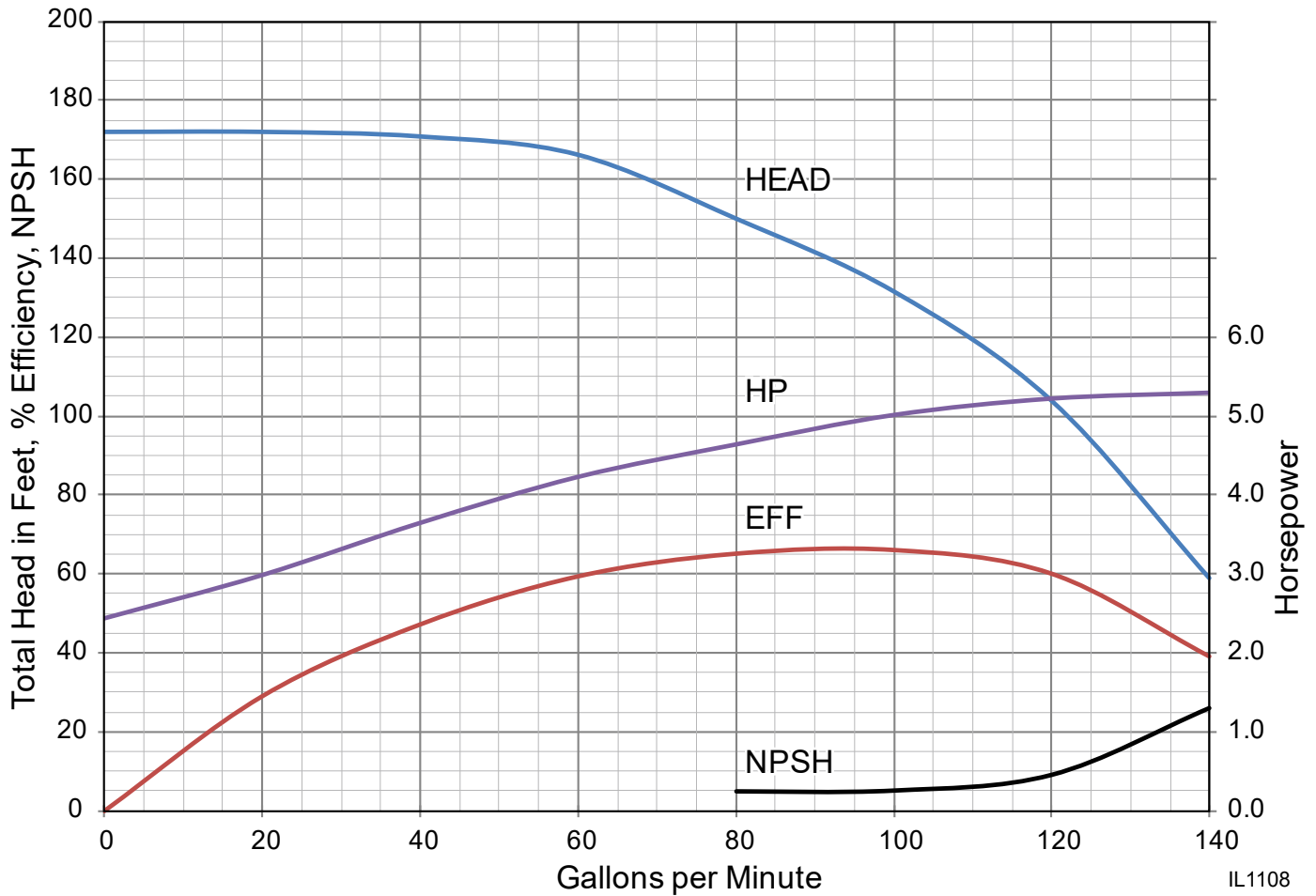

IL1108

PUMP PERFORMANCE CURVES



END SUCTION CENTRIFUGALS

C22273 **7-1/2 HP Three Phase**
3450 RPM **60 Hz**
Two Stage
Impeller No. 134982 & 134975 5.25 O.D.
Suction 3" NPT
Discharge 2" NPT
Max. Case Pressure 120 PSI
Liquid 1.0 Sp. Gr.

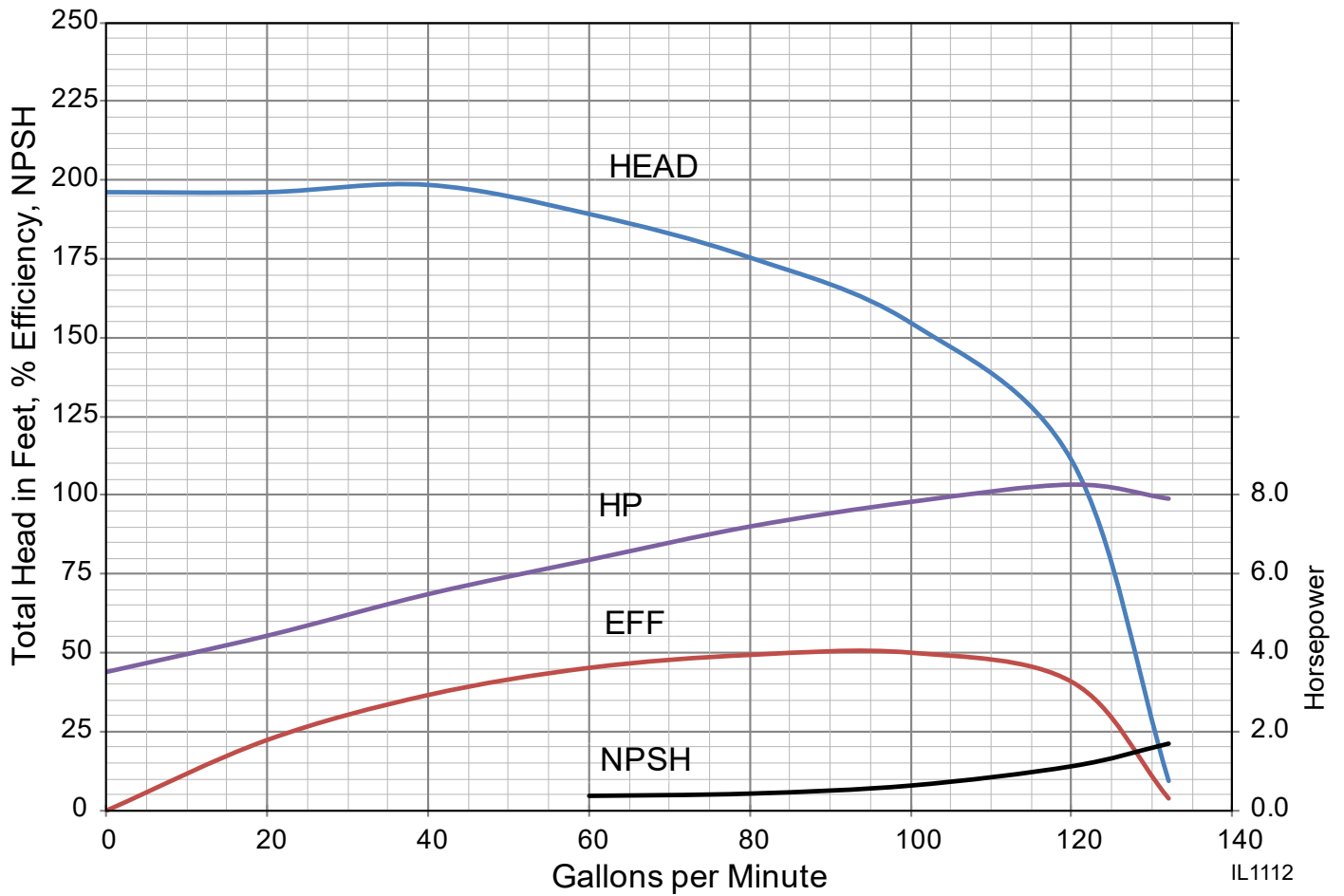

CENTRIFUGAL DIMENSIONS

CJ103 SERIES

	HP	A	B	C	D	E	F	G	H	J	K	L
	1/3	4	4-5/8	3-11/16	5	9-1/2	2-1/8	8-1/4	8-1/8	13-1/4	3-7/8	-
	1/2	4	4-5/8	3-11/16	5	9-1/2	2-1/8	8-1/4	8-1/8	13-1/2	3-7/8	-
	3/4	4	4-5/8	3-11/16	5	9-1/2	2-1/8	8-1/4	8-1/8	14	3-7/8	-
	1	4	4-5/8	3-11/16	5	9-1/2	2-1/8	8-1/4	8-1/8	14-1/2	3-7/8	10-1/4
	1-1/2	4	4-5/8	3-11/16	5	9-1/2	2-1/8	8-1/4	8-1/8	15-1/8	3-7/8	10-1/4
1 Phase	3	4	4-5/8	3-11/16	5	9-1/2	2-1/8	8-1/4	8-1/8	15-5/8	3-7/8	10-1/4
3 Phase	2	4	4-5/8	3-11/16	5	9-1/2	2-1/8	8-1/4	8-1/8	15-5/8	3-7/8	-

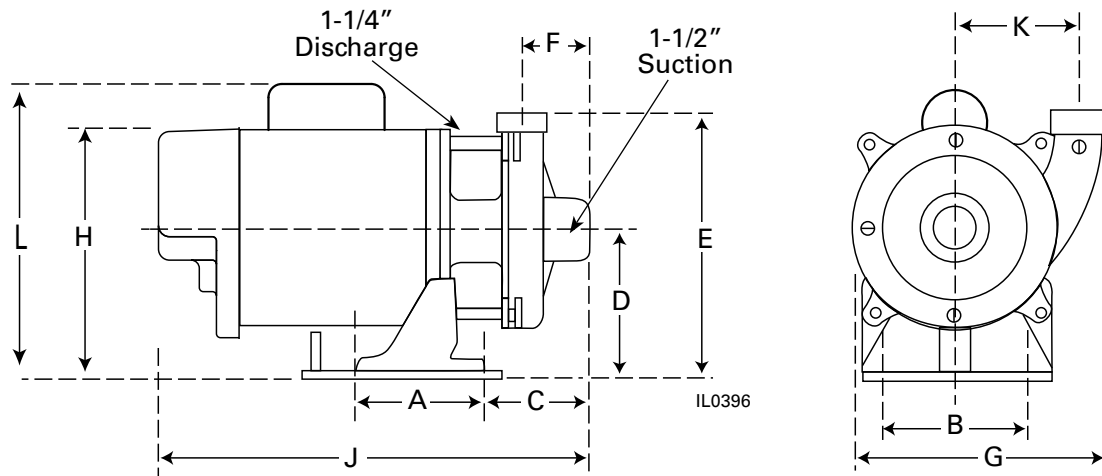

CJ101 SERIES

	HP	STAGE	A	B	C	D	E	F	G	H	J	L
	3/4	2	4	4-5/8	7-9/16	5-1/4	9-1/4	6-1/4	7	8-1/2	17-7/8	-
	1	2	4	4-5/8	7-9/16	5-1/4	9-1/4	6-1/4	7	8-1/2	18-3/8	-
	1-1/2	2	4	4-5/8	7-9/16	5-1/4	9-1/4	6-1/4	7	8-1/2	19	-
	2	2	4	4-5/8	7-9/16	5-1/4	9-1/4	6-1/4	7	8-1/2	19-1/2	-
	2	3	4	4-5/8	9-7/16	5-1/4	9-1/4	8-1/8	7	8-1/2	21-3/8	-
	3	3	4	4-5/8	9-7/16	5-1/4	9-1/4	8-1/8	7	8-1/2	21-3/8	10-5/8

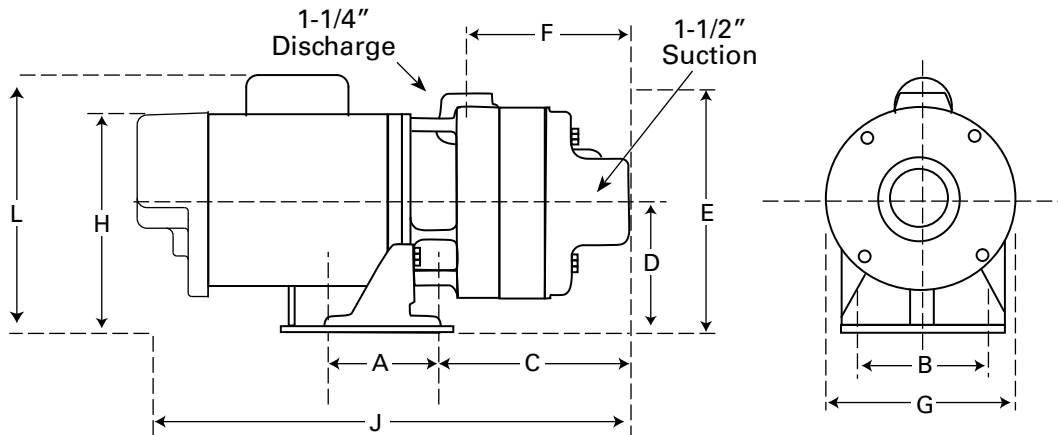

CENTRIFUGAL DIMENSIONS



C22000												
HP	STAGE	PH	A	B	C	D	E	F	G	H	J	K
3	2	1	4-1/2	7-1/2	11-3/4	4-1/2	10-13/16	5-11/16	10-7/8	10-11/16	20-5/8	3-7/16
3	2	3	5	5-1/2	11-1/8	3-1/2	9-13/16	5-11/16	10-3/16	6-7/8	18-1/4	3-7/16
5	2	1	5-1/2	7-1/2	11-3/4	4-1/2	10-13/16	5-11/16	10-13/16	11-3/16	20-5/8	3-7/16
5	2	3	4-1/2	7-1/2	11-3/4	4-1/2	10-13/16	5-11/16	10-13/16	8-7/16	20-5/8	3-7/16
7-1/2	2	3	5-1/2	7-1/2	11-3/4	4-1/2	10-13/16	5-11/16	10-13/16	8-7/16	20-5/8	3-7/16

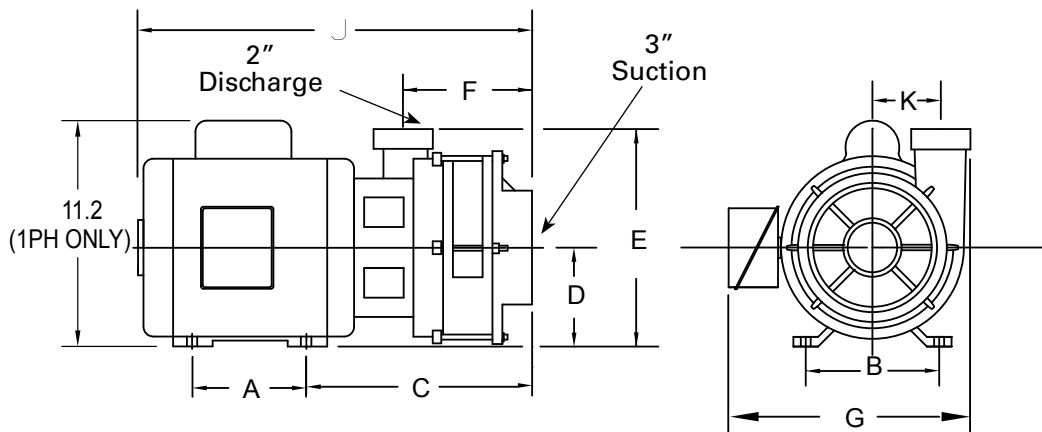

IL1106